



(11) **EP 1 498 728 B1**

(12) **EUROPEAN PATENT SPECIFICATION**

(45) Date of publication and mention of the grant of the patent:
20.02.2008 Bulletin 2008/08

(21) Application number: **03717661.7**

(22) Date of filing: **18.04.2003**

(51) Int Cl.:
G01N 27/407^(2006.01) G01N 33/00^(2006.01)

(86) International application number:
PCT/JP2003/005021

(87) International publication number:
WO 2003/091719 (06.11.2003 Gazette 2003/45)

(54) **DETECTING ELECTRODE AND NITROGEN OXIDE SENSOR USING THE SAME**
NACHWEISELEKTRODE UND DIESE VERWENDENDER STICKSTOFFOXIDSSENSOR
ELECTRODE DE DETECTION ET CAPTEUR D'OXYDE D'AZOTE UTILISANT LADITE ELECTRODE

(84) Designated Contracting States:
DE FR GB

(30) Priority: **25.04.2002 JP 2002124946**

(43) Date of publication of application:
19.01.2005 Bulletin 2005/03

(73) Proprietor: **Japan Science and Technology Agency**
Kawaguchi-shi, Saitama 332-0012 (JP)

(72) Inventor: **IMANAKA, Nobuhito**
Kawanishi-shi, Hyogo 666-0117 (JP)

(74) Representative: **Bentz, Jean-Paul et al**
Novagraaf Technologies,
122, rue Edouard Vaillant
92593 Levallois-Perret Cedex (FR)

(56) References cited:
JP-A- 5 296 971 JP-A- 2000 306 426
JP-A- 2001 133 435 JP-A- 2001 194 337
JP-A- 2003 042 999

- ODA A ET AL: "New type of nitrogen oxide sensor with multivalent cation- and anion-conducting solid electrolytes" **SENSORS AND ACTUATORS B, ELSEVIER SEQUOIA S.A., LAUSANNE, CH, vol. 93, no. 1-3, 1 August 2003 (2003-08-01), pages 229-232, XP004437103 ISSN: 0925-4005**
- ATSUSHI ODA: 'Kidorui no okishi shosan'en o kenshutsukyoku ni mochiita shinki na kotai denkaishitsugata NO gas sensor' **THE ELECTRO-CHEMICAL SOCIETY OF JAPAN DAI 69 KAI TAIKAI KOEN YOSHISHU 25 March 1996, page 44, XP002969948**
- NOBUHIRO IMANAKA: 'Nitrogen monoxide gas sensor based on solid electrolytes with a water-insoluble oxide based auxiliary electrode' **ELECTROCHEMICAL AND SOLID-STATE LETTERS vol. 5, no. 11, 27 August 2002, pages H25 - H26, XP002969949**

Note: Within nine months from the publication of the mention of the grant of the European patent, any person may give notice to the European Patent Office of opposition to the European patent granted. Notice of opposition shall be filed in a written reasoned statement. It shall not be deemed to have been filed until the opposition fee has been paid. (Art. 99(1) European Patent Convention).

EP 1 498 728 B1

Description

TECHNICAL FIELD

5 **[0001]** The present invention relates in general to nitrogen oxide sensor electrodes and nitrogen oxide sensor incorporating such electrodes and in particular to, besides nitrogen oxides which are a sensor target, nitrogen oxide sensor electrodes and nitrogen oxide sensors which exhibit excellent responsiveness to nitrogen oxides in a humid atmosphere containing water vapor.

10 BACKGROUND ART

[0002] Nitrogen oxides, consisting mainly of nitrogen monoxide (NO) and nitrogen dioxide (NO₂), is a toxic gas. They are a major cause of acid rain and other kinds of acidic fallings and one of seriously threatening factors to human health and environment. To restrict the amount of nitrogen oxides in the air, nitrogen oxide discharges from vehicles, various factories, etc. need to be brought under control. To this end, the amount of nitrogen oxide discharges from these sources must be placed under constant sensing, that is, monitoring.

15 **[0003]** In the event of, for example, a huge nitrogen oxide discharge caused by a certain malfunction of a nitrogen oxide source, such monitoring enables quick actions to be taken to prevent further nitrogen oxide leakage. This example illustrates how effective it is to sense/monitor the amount of nitrogen oxides discharged from sources to restrict their total amount in the air.

[0004] The sensing/monitoring of nitrogen oxide discharges from various sources requires compact, cheap, and easy-to-service nitrogen oxide sensors. The most promising of those sensors is one based on solid electrolyte in view of the desired capability, quick responsiveness, and quantitative sensing. This type of sensor is also suited to selective sensing of particular gases because a single type of ions migrate in a solid. Nitrogen oxide sensors are being suggested using various solid electrolytes.

25 **[0005]** Typically, nitrogen oxides are produced in combustion. So are heat and water vapor. Therefore, from a practical point of view, the solid electrolyte and sensor electrode used in a nitrogen oxide sensor need to be operational at high temperatures and impervious to water vapor. Thus, the desirable nitrogen oxide sensor electrode and nitrogen oxide sensor are capable of quick and quantitative sensing of nitrogen oxides in a humid atmosphere containing water vapor for practical purposes.

30 **[0006]** Since the sensor is expected to detect nitrogen oxide gases, its electrode needs to contain NO⁺, NO₂⁻, and NO₃⁻ of nitrogen oxide origin.

[0007] However, the operational temperature of the nitrogen oxide sensor electrode, which conducts NO⁺, should not exceed 200 degrees Celsius, restricting the sensor's applications. In addition, since both NO₂⁻ and NO₃⁻ are soluble in water, they are not suited to measurement in a humid atmosphere containing water vapor. For these reasons, there is no conventional nitrogen oxide sensor electrode that works well at high temperatures in a water-vapor-containing atmosphere.

35 **[0008]** Further, conventional solid electrolytes, which are soluble in water, cannot be used to detect nitrogen oxides in a humid atmosphere containing water vapor. This is another cause making it difficult to build a nitrogen oxide sensor usable in a water-vapor atmosphere for practical purposes.

[0009] JP 2001 - 133435 A discloses a nitrogen oxide detecting electrode including a carbonate of an alkali metal and an oxide of a rare-earth element.

40 **[0010]** Conceived to address these problems, the present invention has an objective to, especially, provide a highly water-insoluble, excellent practical performance nitrogen oxide sensor electrode, and a nitrogen oxide sensor incorporating such an electrode, which is useable for measurement in a high-temperature, humid atmosphere containing water vapor.

DISCLOSURE OF INVENTION

50 **[0011]** The sensor electrode of the present invention, to achieve the objective, is characterized by the inclusion of: a solid solution of a nitrate or nitrite of an alkali metal and an oxide of a rare-earth element.

[0012] With these features, a nitrogen oxide sensor electrode can be made which is suited to nitrogen oxide sensing, especially, in a hot and humid atmosphere containing water vapor. Specifically, the nitrate/nitrite replaces part of the lattice of the oxide, which is highly water-insoluble, thereby forming a solid solution. Thus, atmospheric water vapor is prevented from affecting NO₂⁻/NO₃⁻ in the nitrate/nitrite of the alkali metal. Nitrogen oxide sensing in a humid atmosphere thus becomes possible. In addition, nitrogen oxide sensing at high temperatures becomes possible.

55 **[0013]** For example, by incorporating that nitrogen oxide sensor electrode in a nitrogen oxide sensor, the sensor becomes capable of nitrogen oxide sensing in a not only in dry, but also humid atmosphere. The nitrogen oxide sensor

thus made is highly practical: it works well at high temperatures and quickly and quantitatively sense nitrogen oxides without being affected by atmospheric water vapor. The nitrogen oxide sensor electrode is especially suitable for use in a nitrogen oxide sensor built around a solid electrolyte, imparting very good nitrogen oxide responsiveness to the nitrogen oxide sensor.

5 **[0014]** As to the sensor electrode of the present invention, the oxide of the rare-earth element is preferably Eu_2O_3 , Y_2O_3 or Gd_2O_3 . In addition, the nitrate/nitrite of the alkali metal is preferably a nitrite of an alkali metal, more preferably KNO_2 .

[0015] With these features, a more practical nitrogen oxide sensor can be made which is usable at high temperatures and quickly and quantitatively senses nitrogen oxides without being affected by atmospheric water vapor.

10 **[0016]** The nitrogen oxide sensor in accordance with the present invention is characterized by the inclusion of: the foregoing nitrogen oxide sensor electrode, a solid electrolyte, and an oxide ion conductor. The sensor electrode and the oxide ion conductor are provided in contact with the surface of the solid electrolyte. The solid electrolyte conducts magnesium ions, aluminum ions, rare earth ions, zirconium ions, or hafnium ions.

[0017] With these features, the nitrogen oxide sensor is highly practical: it exhibits high water-insolubility and is suitable for measurement in a humid atmosphere containing water vapor.

15 **[0018]** Specifically, as the solid electrolyte, a conductor material for magnesium ions, aluminum ions, rare earth ions, zirconium ions, or hafnium ions is used. Thus, the solid electrolyte is highly water-insoluble. In addition, with the combined use of the nitrogen oxide sensor electrode and an oxide ion conductor, which is typically highly insoluble in water, the nitrogen oxide sensor exhibits high water-insolubility.

20 **[0019]** This ensures that atmospheric water vapor does not affect the sensing of nitrogen oxide concentrations in a humid atmosphere.

[0020] Hence, for example, the nitrogen oxide sensor is capable of sensing nitrogen oxides in vehicle exhaust emissions, which contain both nitrogen oxides and water vapor.

[0021] In addition, as the nitrogen oxide sensor in accordance with the present invention, it is preferred if the solid electrolyte is sandwiched between the nitrogen oxide sensor electrode and the oxide ion conductor.

25 **[0022]** The positioning of the solid electrolyte between the nitrogen oxide sensor electrode on the surface of the solid electrolyte and the oxide ions enables efficient nitrogen oxide sensing of cations moving in the solid electrolyte through the oxide ion conductor, improving nitrogen oxide sensing efficiency. This electrode-electrolyte-conductor structure is obtained for example by providing a sensor electrode on one side of a board-shaped solid electrolyte surface and providing an oxide ion conductor on the other side.

30 **[0023]** As to the nitrogen oxide sensor in accordance with the present invention, it is preferred if solid electrolyte has a Nasicon or β -iron sulfate crystal structure. The solid electrolyte is preferably a complex of $\text{Mg}_{1+x}\text{Zr}_4\text{P}_6\text{O}_{24+x}$ ($0 < X \leq 0.4$) and $\text{Zr}_2\text{O}(\text{PO}_4)_2$; a solid solution, $\text{Mg}_{1-2Y}(\text{Zr}_{1-Y}\text{Nb}_Y)_4\text{P}_6\text{O}_{24}$ ($0 \leq Y < 1/2$), conducting magnesium ions; a composition, $(\text{Al}_{0.2}\text{Zr}_{0.8})_{20/19}\text{Nb}(\text{PO}_4)_3$, conducting aluminum ions; a composition, $\text{R}_{1/3}\text{Zr}_2(\text{PO}_4)_3$, conducting rare earth ions, where R is a rare earth atom; a composition, $\text{ZrNb}(\text{PO}_4)_3$, conducting zirconium ions; or a composition, $\text{HfNb}(\text{PO}_4)_3$, conducting hafnium ions.

35 **[0024]** As to the nitrogen oxide sensor in accordance with the present invention, it is preferred if the oxide ion conductor is made of at least one of the group consisting of fully stabilized zirconia, cerium oxide, bismuth oxide, hafnium oxide, thorium oxide, and lanthanum gallate.

40 **[0025]** These features better ensure that atmospheric water vapor does not affect the sensing of nitrogen oxide concentrations. Hence, the nitrogen oxide sensor is highly practical: it senses nitrogen oxides with good reproducibility in both dry and humid atmospheres.

45 **[0026]** Additional objects, advantages and novel features of the invention will be set forth in part in the description which follows, and in part will become apparent to those skilled in the art upon examination of the following or may be learned by practice of the invention.

BRIEF DESCRIPTION OF DRAWINGS

[0027]

50 Figure 1 is a schematic showing the arrangement of an example of the nitrogen oxide sensor in accordance with the present invention.

Figure 2 is a spectrum diagram showing results of the X-ray diffraction of powder making up a sensor electrode of example 1.

55 Figure 3 is a graph of a response curve representing the electromotive force of an example 1 nitrogen oxide sensor induced by a NO gas contained in a dry measurement sample.

Figure 4 is a graph showing the electromotive force of example 1 nitrogen oxide sensor induced by a NO gas contained in a dry measurement sample as in Figure 3, with the NO gas concentration being varied both in increasing/

decreasing directions.

Figure 5 is a graph of a response curve representing the electromotive force of example 1 nitrogen oxide sensor induced by a NO gas contained in a water-vapor humid measurement sample.

Figure 6 is a graph showing the electromotive force of example 1 nitrogen oxide sensor induced by a NO gas contained in a humid measurement sample as in Figure 5, with the NO gas concentration being varied both in increasing/decreasing directions.

Figure 7 is a graph showing NO gas concentration dependence of the electromotive force of example 1 nitrogen oxide sensor for the Figure 4 dry case and the Figure 6 humid case.

Figure 8 is a spectrum diagram showing results of the X-ray diffraction of powder making up a sensor electrode of example 2.

Figure 9 is a graph of a response curve representing the electromotive force of an example 2 nitrogen oxide sensor induced by a NO gas contained in a dry measurement sample.

Figure 10 is a graph showing the electromotive force of the example 2 nitrogen oxide sensor induced by a NO gas contained in a dry measurement sample as in Figure 9, with the NO gas concentration being varied both in increasing/decreasing directions.

Figure 11 is a graph of a response curve representing the electromotive force of an example 3 nitrogen oxide sensor induced by a NO gas contained in a dry measurement sample.

Figure 12 is a graph showing the electromotive force of the example 3 nitrogen oxide sensor induced by a NO gas contained in a dry measurement sample as in Figure 11, with the NO gas concentration being varied both in increasing/decreasing directions.

Figure 13 is a graph of a response curve representing the electromotive force of an example 4-1 nitrogen oxide sensor induced by a NO gas contained in a dry measurement sample.

Figure 14 is a graph showing the electromotive force of the example 4 nitrogen oxide sensor induced by a NO gas contained in a dry measurement sample as in Figure 13, with the NO gas concentration being varied both in increasing/decreasing directions.

Figure 15 is a graph of a response curve representing the electromotive force of an example 4 nitrogen oxide sensor induced by a NO₂ gas contained in a dry measurement sample.

Figure 16 is a graph showing the electromotive force of the example 4 nitrogen oxide sensor induced by a NO₂ gas contained in a dry measurement sample as in Figure 15, with the NO₂ gas concentration being varied both in increasing/ decreasing directions.

Figure 17 is a graph showing the electromotive force of the example 4 nitrogen oxide sensor induced by a NO/NO₂ gas mixture contained in a dry measurement sample, with the NO/NO₂ gas concentration being varied both in increasing/ decreasing directions.

Figure 18 is a graph of a response curve representing the electromotive force of the example 4 nitrogen oxide sensor where the NO/NO₂ gas mix ratio in the dry measurement sample is varied.

BEST MODE FOR CARRYING OUT THE INVENTION

[0028] The following is a description of an embodiment of the present invention in reference to Figure 1.

[0029] The nitrogen oxide sensor electrode of the present embodiment is made of a solid solution of a nitrate or nitrite of an alkali metal and an oxide of a rare-earth element. The sensor electrode is suitably used, especially, in nitrogen oxide sensors base on a solid electrolyte.

[0030] First, referring to Figure 1, a nitrogen oxide sensor including the sensor electrode of the present embodiment will be described. As shown in the figure, a nitrogen oxide sensor 10 of the present embodiment includes: a solid electrolyte 1; an oxide ion conductor 2 provided in contact with the surface of the solid electrolyte 1; and a sensor electrode (nitrogen oxide sensor electrode) 3 provided on the surface of the solid electrolyte 1, but opposite the oxide ion conductor 2. In other words, the solid electrolyte 1 is located between the sensor electrode 3 and the oxide ion conductor. The solid electrolyte 1 and the oxide ion conductor 2 are joined using an inorganic adhesion agent 9.

[0031] On the surface of the sensor electrode 3 is there provided a gold net 4, opposite the solid electrolyte 1. On the surface of the oxide ion conductor 2 is there provided a platinum net 5, opposite the solid electrolyte 1. The these gold net 4 and the platinum net 5 are connected respectively to a gold line 6 and a platinum line 7. That is, the oxide ion conductor 2 is connected to the platinum line 7 through the platinum net 5. The sensor electrode 3 is connected to the gold line 6 through the gold net 4.

[0032] Next, the nitrogen oxide sensing mechanism of the nitrogen oxide sensor 10 will be described. When the nitrogen oxide sensor 10 is placed in an atmosphere containing nitrogen oxides, the sensor electrode 3 senses the nitrogen oxides in the atmosphere, causing movement of cations in the solid electrolyte 1.

[0033] At the interface 8 between the solid electrolyte 1 and the oxide ion conductor 2, the cations moving in the solid electrolyte 1 combine with the oxide ions having traveled through the oxide ion conductor 2 to the interface 8, forming

stable oxides.

[0034] This phenomenon creates a force moving the cations, or ion drive force, through the solid electrolyte 1 in its thickness direction, that is, from the sensor electrode 3 side to the oxide ion conductor 2 side of the solid electrolyte 1. The drive force produces a potential difference between the gold net 4 and the platinum net 5. The potential difference has a magnitude in accordance with the nitrogen oxide concentration in the atmosphere, which can be measured across the gold line 6 and the platinum line 7.

[0035] More specifically, the electromotive force across the gold line 6 and the platinum line 7 is in proportion to the sensed nitrogen oxide concentration as mentioned above. Through the measurement of this electromotive force can the atmospheric nitrogen oxide concentration be measured.

[0036] Next, the structural members of the nitrogen oxide sensor 10 will be described.

[0037] The solid electrolyte 1 is preferably a conductor for magnesium ions, aluminum ions, rare earth ions, zirconium ions, or hafnium ions which has a Nasicon or β -iron sulfate crystal structure.

[0038] Here, "Nasicon" refers to a structural design of a crystal with a three-dimensional tunnel through which specific ionic species can readily move in the crystal. In other words, the design allows for movement of specific ionic species. The terminology came from $\text{Na}_{1+x}\text{Zr}_2\text{P}_{8-x}\text{Si}_x\text{O}_{12}$ ($X = 2$), or "Nasicon," which contains a sodium ion (Na^+) as a movable ionic species.

[0039] Similarly to the Nasicon crystal structure, the β -iron sulfate crystal structure also includes a three-dimensional tunnel through which specific ionic species can readily move in the crystal.

[0040] As the solid electrolyte 1 conducting sodium ions, specific examples include complexes of $\text{Mg}_{1+x}\text{Zr}_4\text{P}_6\text{O}_{24+x}$ ($0 < X \leq 0.4$) and $\text{Zr}_2\text{O}(\text{PO}_4)_2$ and solid solutions of $\text{Mg}_{1-2Y}(\text{Zr}_{1-Y}\text{Nb}_Y)_4\text{P}_6\text{O}_{24}$ ($0 \leq Y < 1/2$) compositions.

[0041] A complex of such a composition may be prepared by, for example, mixing $\text{MgHPO}_4 \cdot 3\text{H}_2\text{O}$, $\text{ZrO}(\text{NO}_3)_2 \cdot 2\text{H}_2\text{O}$, and $\text{NH}_4\text{H}_2\text{PO}_4$ in powder form at a predetermined ratio, then molding the powder mixture to give it a predetermined shape and size, and firing the molded mixture under predetermined conditions. The complex may however be prepared otherwise. The description hereafter on preparation methods for other materials are by no means limiting. The materials may be prepared by any other, non-described method.

[0042] The solid solution may be prepared by, for example, mixing $\text{MgHPO}_4 \cdot 3\text{H}_2\text{O}$, $\text{ZrO}(\text{NO}_3)_2 \cdot 2\text{H}_2\text{O}$, Nb_2O_5 , and $\text{NH}_4\text{H}_2\text{PO}_4$ in powder form at a predetermined ratio and if necessary, firing the powder mixture. The obtained powder mixture is then molded to give it a predetermined shape and size, for example, pellets, and fired under predetermined conditions.

[0043] The solid electrolyte 1 conducting aluminum ions is exemplified by a composition, $(\text{Al}_{0.2}\text{Zr}_{0.8})_{20/19}\text{Nb}(\text{PO}_4)_3$.

[0044] Such a solid electrolyte may be prepared by mixing $\text{Al}(\text{OH})_3$, $\text{ZrO}(\text{NO}_3)_2 \cdot 2\text{H}_2\text{O}$, Nb_2O_5 , and $(\text{NH}_4)_2\text{HPO}_4$ at a predetermined ratio and if necessary, firing the powder mixture. The obtained powder mixture is then molded to give it a predetermined shape and size, for example, pellets, and fired under predetermined conditions.

[0045] Another example of the solid electrolyte 1 conducting aluminum ions is a composition, $\text{Al}_{1/3}\text{Zr}_2(\text{PO}_4)_3$. This particular solid electrolyte may be prepared by mixing $\text{Al}(\text{OH})_3$ and $\text{ZrO}(\text{NO}_3)_2 \cdot 2\text{H}_2\text{O}$ at a predetermined ratio and if necessary, firing the powder mixture. The obtained powder mixture is then molded to give it a predetermined shape and size, for example, pellets, and fired under predetermined conditions.

[0046] The solid electrolyte 1 conducting rare earth ions is exemplified by a composition, $\text{R}_{1/3}\text{Zr}_2(\text{PO}_4)_3$ (R is a rare earth atom). A solid electrolyte of the composition, $\text{R}_{1/3}\text{Zr}_2(\text{PO}_4)_3$, may be prepared by mixing R_2O_3 and $\text{ZrO}(\text{NO}_3)_2 \cdot 2\text{H}_2\text{O}$ both in powder form at a predetermined ratio and if necessary, firing the powder mixture. The obtained powder mixture is then molded to give it a predetermined shape and size, for example, pellets, and fired under predetermined conditions. The rare earth atom represented by R in the formula is preferably scandium.

[0047] The solid electrolyte 1 conducting zirconium ions is exemplified by a composition, $\text{ZrNb}(\text{PO}_4)_3$. A solid electrolyte of the composition, $\text{ZrNb}(\text{PO}_4)_3$, may be prepared by mixing ZrO_2 and Nb_2O_5 both in powder form at a predetermined ratio and if necessary, firing the powder mixture. The powder mixture is then molded to give it a predetermined shape and size, for example, pellets, and fired under predetermined conditions.

[0048] The solid electrolyte 1 conducting hafnium ions is exemplified by a composition, $\text{HfNb}(\text{PO}_4)_3$. Such a solid electrolyte of the composition, $\text{HfNb}(\text{PO}_4)_3$, may be prepared by mixing $\text{Hf}(\text{SO}_4)_2$ and Nb_2O_5 both in powder form at a predetermined ratio and, if necessary, firing the powder mixture. The obtained powder mixture is then molded to give it a predetermined shape and size, for example, pellets, and fired under predetermined conditions.

[0049] The shape of the solid electrolyte 1 is determined as necessary and not limited in any particular manner. Examples are a disc and a rectangular flat board. A board shape with a substantially constant thickness is preferred. As shown in Figure 1, the solid electrolyte 1 is of a disc shape in the present embodiment.

[0050] The thickness of the solid electrolyte 1 is preferably from 0.1 mm to 1.5 mm, more preferably less than 1.0 mm. These low thicknesses reduce internal resistance.

[0051] The part of the surface of the solid electrolyte 1 where it is in contact with the oxide ion conductor 2 is preferably from 10 mm^2 to 200 mm^2 , more preferably from 50 mm^2 to 100 mm^2 .

[0052] The oxide ion conductor 2 is not limited in any particular manner. The conductor 2 may be anything that allows

for oxide ion movement. Preferred examples are fully stabilized zirconia, cerium oxide, bismuth oxide, hafnium oxide, thorium oxide, lanthanum gallate, and any of their combinations. In other words, the oxide ion conductor 2 may be composed of only one of these listed compounds or more than one of the compounds.

[0053] The shape of the oxide ion conductor 2, although determined in accordance with the solid electrolyte 1, is not limited in any particular manner. Examples are a disc and a rectangular flat board. As shown in Figure 1, a board shape with a substantially constant thickness is preferred. The thickness of the oxide ion conductor 2 is preferably from 0.1 mm to 1.5 mm, more preferably less than 1.0 mm. These low thicknesses reduce internal resistance.

[0054] The part of the surface of the oxide ion conductor 2 where it is in contact with the solid electrolyte 1 is preferably from 10 mm² to 200 mm², more preferably from 50 mm² to 100 mm².

[0055] The sensor electrode 3 contains a solid solution of either a nitrate or nitrite of an alkali metal and an oxide of a rare-earth element. Used with the oxide of the rare-earth element, the nitrate/nitrite of the alkali metal replaces part of the lattice of the oxide, forming a solid solution. Thus, the sensor electrode 3 exhibits high water-insolubility, making it possible to install the nitrogen oxide sensor 10, incorporating the sensor electrode 3, in a humid atmosphere containing water vapor. The sensor 10 is thus rendered highly practical. The oxide of the rare-earth element is preferably Eu₂O₃, Y₂O₃, or Gd₂O₃. The nitrite of the alkali metal is preferably KNO₂.

[0056] The sensor electrode 3 is specified where necessary, similarly to the solid electrolyte 1. Although not limited in any particular manner, the electrode 3 may be, for example, of a disc or rectangular flat board shape. In the case of a board shape, the thickness of the sensor electrode 3 is preferably from 0.1 mm to 1.0 mm, more preferably from 0.5 mm to 0.8 mm.

[0057] The part of the surface of the sensor electrode 3 where it is in contact with the solid electrolyte 1 is preferably from 10 mm² to 200 mm², more preferably from 10 mm² to 30 mm². The solid electrolyte 1 side of the sensor electrode 3 is preferably from 80% to 120%, more preferably from 90% to 110%, of the sensor electrode 3 side of the solid electrolyte 1.

[0058] To achieve good responsiveness of the sensor electrode 3, it is preferred if the nitrite and the rare earth oxide are well mixed to form a solid, e.g., a solid solution. For this purpose, it is expected that rare-earth element oxides with a large ion radius are ready to form a solid solution with a nitrite.

[0059] Therefore, among rare-earth element oxides, oxides of Sm, Eu, Gd are prospective candidates.

[0060] In addition, the nitrogen oxide sensor 10 in accordance with the present invention is capable of detecting nitrogen oxides in a water-vapor atmosphere and at high temperatures with excellent reproducibility. This is because of the heat- and water-resistance of the rare-earth element oxide and the good formation of a solid (solid solution) made of the rare-earth element oxide and the alkali metal nitrite.

Examples

[0061] Next, the present invention will be described in further detail through examples. The invention is however by no means limited by these examples.

Example 1

[0062] The following will describe a nitrogen oxide sensor which is an example of the present invention, as well as the solid electrolyte, the oxide ion conductor, and the sensor electrode, in reference to Figure 1 to Figure 7.

Solid electrolyte

[0063] The nitrogen oxide sensor of the present example is constructed as shown in the schematic of Figure 1. A solid electrolyte 1 which was a component of the nitrogen oxide sensor 10 of the present example was fabricated as follows: Al(OH)₃, ZrO(NO₃)₂·2H₂O, Nb₂O₅, and (NH₄)₂HPO₄ in powder form was mixed at a molar ratio of Al(OH)₃:ZrO(NO₃)₂·2H₂O:Nb₂O₅:(NH₄)₂HPO₄ = 8:32:19:114. The mixture was heated in the air up to 1000 degrees Celsius and then at that temperature for 12 hours. After the heating, the mixture was crushed to form pellets and heated in the air at 1200 degrees Celsius for 12 hours and subsequently at 1300 degrees Celsius for 12 hours.

[0064] The pellets mixture thus heated was crush again and sintered through heating in the air at 1300 degrees Celsius for 12 hours. Thus, (Al_{0.2}Zr_{0.8})_{20/19}Nb(PO₄)₃, as the solid electrolyte 1 of a disc shape, was prepared which conducted aluminum ions (Al³⁺). The solid electrolyte 1 was 1.0 mm thick. The part of its surface where it is in contact with the oxide ion conductor 2 was 95 mm². So was that where it is in contact with the sensor electrode 3.

Oxide Ion Conductor

[0065] An oxide ion conductor 2 which was a component of the nitrogen oxide sensor 10 of the present example was

fabricated as follows: ZrO_2 and Y_2O_3 in powder form was mixed at a molar ratio of $ZrO_2:Y_2O_3 = 9:1$. The mixture was fired in the air at 1600 degrees Celsius for 12 hours. The firing process was carried out twice. Thus, $(ZrO_2)_{0.9}(Y_2O_3)_{0.1}$, as the oxide ion conductor 2 of a disc shape, was prepared which was made up of fully stabilized zirconia. The oxide ion conductor 2 was 1.0 mm thick. The part of its surface where it is in contact with the solid electrolyte 1 was 95 mm². That is, in the present example, the oxide ion conductor 2 was made in the same shape as the solid electrolyte 1. $(ZrO_2)_{0.9}(Y_2O_3)_{0.1}$ will be abbreviated as YSZ.

Sensor electrode

[0066] A sensor electrode 3 which was a component of the nitrogen oxide sensor 10 of the present example was fabricated as follows: Europium oxide Eu_2O_3 and potassium nitrite KNO_2 in powder form were mixed at a molar ratio of $Eu_2O_3:KNO_2 = 2:1$. The mixture was mixed in the air for 12 hours using a ball mill. The powder mixture thus mixed was then molded to form pellets and sintered through heating at 450 degrees Celsius for 12 hours. Thus, the sensor electrode 3 was obtained.

[0067] The sensor electrode 3 thus fabricated was subjected to X-ray diffraction for measurement of the powder (X-ray diffractionmetry, or XRD). Results are shown in Figure 2.

[0068] Referring to the figure, the X-ray crystal diffraction for the sensor electrode 3 detected a single peak, which indicated Eu_2O_3 . A peak shift was confirmed. In other words, the figure showed changes in the lattice size caused by K replacing some of Eu, which in turn showed that Eu_2O_3 and KNO_2 had formed a solid solution.

[0069] Replacing Eu with K changes the lattice size because of the size difference between these elements. In the figure, $(Eu_{0.8}K_{0.2})_2O_{2.6}$ indicates $Eu_2O_3 + 0.2KNO_2$. $(Eu_{0.7}K_{0.3})_2O_{2.4}$ indicates $Eu_2O_3 + 0.3KNO_2$.

Nitrogen oxide sensor

[0070] The solid electrolyte 1 and oxide ion conductor 2 thus fabricated were stacked as shown in Figure 1. The side face was covered with an inorganic adhesion agent 9 to seal out the interface 8 between the solid electrolyte 1 and the oxide ion conductor 2 from the external atmosphere. In the present example, Sumiceram 17D (product name; manufactured by Asahi Chemical Co., Ltd.) was used as the inorganic adhesion agent 9.

[0071] The sensor electrode 3 was then stacked onto the disc-shape solid electrolyte 1 which conducts aluminum ions Al^{3+} , so that the former comes in contact with the surface of the latter. The two were then fixed to each other. A gold net 4 and a gold line 6 were provided as shown in Figure 1 which would be the electrode and lead line on the sensor electrode 3 side of the solid electrolyte 1. A platinum net 5 and a platinum line 7 were also provided which would be the electrode and lead line on the oxide ion conductor 2 side of the solid electrolyte 1, which completes the fabrication of the nitrogen oxide sensor 10 of the present example.

Conditions in nitrogen oxide measurement

[0072] Samples were prepared for nitrogen oxide measurement. The samples were prepared by mixing 1% N_2 -diluted NO with air, with the NO concentration as the nitrogen oxide being varied between 200 ppm and 2000 ppm. This NO concentration range equates that in vehicle exhaust emissions which are a common nitrogen oxide source.

[0073] The measurement temperature was set to 450 degrees Celsius. The total flow of the measurement sample (gas) was maintained at 100 ml/minute so that the oxygen concentration in the measurement sample would be always 20 wt. %. The output of the nitrogen oxide sensor 10 was measured using an electrometer, R8240, manufactured by Advantest Corp.

Preparation of measurement sample containing water vapor

[0074] A measurement sample containing 4.87 g/m³ water vapor was prepared by passing 1% N_2 -diluted NO through deionized water so that the latter would bubble and mix with the former. During the bubbling, the latter was placed in a triangle flask in a thermostatic bath which was regulated at 25 degrees Celsius.

Sensing principles

[0075] The following depicts the sensing principles of the nitrogen oxide sensor 10 of the present example fabricated in the foregoing manner, specifically, the reactions likely to be taking place in the sensor electrode 3, at the interface between the sensor electrode 3 and the solid electrolyte 1, at the interface 8 between the oxide ion conductor 2 and the solid electrolyte 1, and in the reference electrode.

Sensor electrode

[0076]

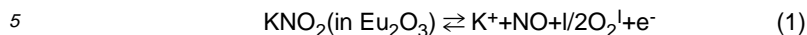

Sensor electrode/solid electrolyte interface

10 [0077]

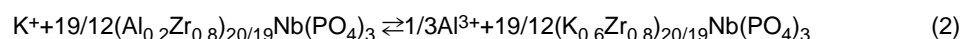

15 Oxide ion conductor/solid electrolyte interface

[0078]

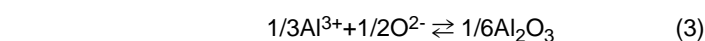

Reference electrode

[0079]

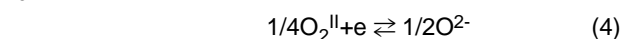

[0080] The net reaction in the nitrogen oxide sensor 10 is given by equation (5):

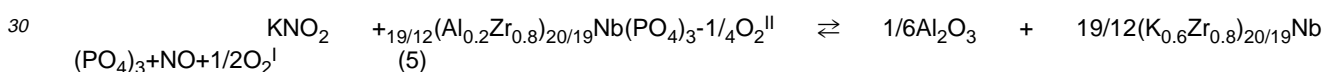

[0081] Hence, based on the Nernst equation, the electromotive force E appearing between the gold line 6 and platinum line 7 on the nitrogen oxide sensor 10 is given by equation (6):

$$35 \quad E = E_o - (R/nF)T \ln \left\{ \frac{(a\text{Al}_2\text{O}_3)^{1/6} (a(\text{K}_{0.6}\text{Zr}_{0.8})_{20/19}\text{Nb}(\text{PO}_4)_3)^{19/12} (P_{\text{NO}})(\text{PO}_2^{\text{I}})^{1/2} (a\text{KNO}_2)^{-1} (a(\text{Al}_{0.2}\text{Zr}_{0.8})_{20/19}\text{Nb}(\text{PO}_4)_3)^{-19/12} (P_{\text{O}_2^{\text{II}}})^{-1/4}}{(E_o = \text{constant number, } n = 1.00)} \right\} \quad (6)$$

where R is the gas constant, F is the Faraday's constant, T is the absolute temperature, a is an activity, and P is a partial pressure.

[0082] As mentioned earlier, the oxygen concentration in the measurement sample is regulated at a constant value of 20 wt. %. Therefore, O_2^{I} and O_2^{II} have an equal partial pressure of $2.1 \text{ Pa} \times 10^4 \text{ Pa}$ (indicated by PO_2^{I} and PO_2^{II} respectively). So, there is no effect of oxygen's partial pressure. Since the activity of a solid is constant, equation (6) giving the electromotive force E of the nitrogen oxide sensor 10 can be rearranged to simple equation (7):

$$45 \quad E = E_o' - (R/nF)T \ln(P_{\text{NO}}) \quad (n=1.0) \quad (E_o' = \text{constant number, } n = 1.00) \quad (7)$$

Evaluation of nitrogen oxide sensor

[0083] The response of the nitrogen oxide sensor 10 to NO gases (200 ppm to 2000 ppm) was measured at 450 degrees Celsius under conditions detailed above. Results are shown in Figures 3 to 7.

Sensing in dry atmosphere

[0084] Figure 3 is a response curve representing the electromotive force of the nitrogen oxide sensor 10 induced by NO gases in dry measurement samples. The response curve in the figure was observed when the NO gas concentration was varied between 200 and 2000 ppm. The figure indicates that the electromotive force (output) of the nitrogen oxide

sensor 10 in a dry atmosphere monotonically increased with a decrease in the NO gas concentration and monotonically decreased with an increase in the NO gas concentration. Further, the figure indicates that the response reached 90% of the full response level within 10 minutes. It would be understood that the reactions in the nitrogen oxide sensor 10 were quick, continuous, and highly reproducible, which translated into the good response of the nitrogen oxide sensor 10.

[0085] Now, moving to Figure 4, it would be understood that the response of the nitrogen oxide sensor 10 is reversible, because the electromotive force assumed reproducible values both in cases where the NO gas concentration increased (white squares) and where it decreased (black circles).

Sensing in humid atmosphere

[0086] Figure 5 is a response curve representing the electromotive force of the nitrogen oxide sensor 10 induced by NO gases in water-vapor humid measurement samples. As shown in the figure, the electromotive force (output) of the nitrogen oxide sensor 10 in a humid atmosphere containing water vapor monotonically increased with a decrease in the NO gas concentration and monotonically decrease with an increase in the NO gas concentration. The figure also indicates that the response reached 90% of the full response level within 10 minutes, similarly to the sensing in a dry atmosphere. It would be understood that the response was quick, continuous, and highly reproducible.

[0087] Referring to Figure 6, the response of the nitrogen oxide sensor 10 is reversible again in a humid atmosphere, similarly to a dry atmosphere, because the electromotive force assumed reproducible values both in cases where the NO gas concentration increased (white squares) and where it decreased (black circles).

Comparison of dry/humid atmosphere

[0088] Figure 7 depicts the relationship between (i) the relationship between the electromotive force and the NO gas concentration in the dry measurement sample in Figure 4, (ii) the relationship between the electromotive force and the NO gas concentration in the humid measurement sample in Figure 6, and (iii) the electromotive force and the NO gas concentration calculated from equation (7). Referring to the figure, the measurements on dry samples (white circles) and the measurements on humid samples (black circles) both exhibit a one-to-one correspondence between the electromotive forces of the nitrogen oxide sensor 10 and the logarithms of the NO gas concentrations.

[0089] In addition, the measurements on dry and humid samples are equal throughout the concentration range. The nitrogen oxide sensor 10 is highly practical for its ability to sense NO gas without being affected by the water vapor in the samples. This is probably because water-soluble KNO_2 , which is involved in the response of the nitrogen oxide sensor 10, replaced part of the lattice of highly water-resistant Eu_2O_3 , forming a solid solution.

[0090] Still referring to Figure 7, electromotive forces were plotted against NO gas concentrations for both dry and humid samples, so as to determine the number of electrons transferred in the reaction, assigned n , in equation (7). Results showed $n = 1.19$ for dry samples and $n = 1.18$ for humid samples. Both values are very near the theoretical number of electrons transferred in the reaction ($n = 1.00$) calculated from equation (7). It is therefore understood that theoretical reactions, as in equations (1) to (7), were taking place in the nitrogen oxide sensor 10 both for dry and humid samples.

[0091] As in the foregoing, the electromotive force of the nitrogen oxide sensor 10, which is built around the combination of the solid electrolyte 1 conducting trivalent aluminum cations, the oxide ion conductor 2 conducting divalent oxide anions, and the sensor electrode 3 made up of highly water-insoluble oxides, complies with the Nernst equation. The reactions in the nitrogen oxide sensor 10 are quick, continuous, and highly reproducible.

[0092] In addition, the nitrogen oxide sensor 10 demonstrates high sensing capability not only in a dry atmosphere, but also a hot and humid atmosphere. Therefore, the sensor electrode 3 and the nitrogen oxide sensor 10 are both highly practical and suited to the detection of nitrogen oxides produced together with water vapor in combustion.

Example 2

[0093] The following will describe a nitrogen oxide sensor which is another example of the present invention, as well as the solid electrolyte, the oxide ion conductor, and the sensor electrode, in reference to Figure 1 and Figure 8 to Figure 10.

Solid electrolyte and oxide ion conductor

[0094] The nitrogen oxide sensor of the present example is constructed as shown in the schematic of Figure 1. The solid electrolyte 1 and the oxide ion conductor 2, which were components of the nitrogen oxide sensor 10 of the present example, were fabricated identically to example 1.

Sensor electrode

[0095] The sensor electrode 3, which was a component of the nitrogen oxide sensor 10 of the present example, was fabricated identically to example 1, except that the europium oxide Eu_2O_3 in example 1 was replaced with yttrium oxide Y_2O_3 .

[0096] The sensor electrode 3 thus fabricated was subjected to X-ray diffraction for measurement of the powder (X-ray diffractionmetry, or XRD). Results are shown in Figure 8.

[0097] Referring to the figure, the X-ray crystal diffraction for the sensor electrode 3 sample detected a single peak, which indicated Y_2O_3 . A peak shift was confirmed. This shows that KNO_2 replaced part of the lattice of Y_2O_3 , forming a solid solution. In the figure, $(\text{Y}_{0.8}\text{K}_{0.2})_2\text{O}_{2.6}$ indicates $\text{Y}_2\text{O}_3 + 0.2\text{KNO}_2$. $(\text{Y}_{0.7}\text{K}_{0.3})_2\text{O}_{2.4}$ indicates $\text{Y}_2\text{O}_3 + 0.3\text{KNO}_2$.

Nitrogen oxide sensor

[0098] As mentioned earlier, the nitrogen oxide sensor 10 of the present example was fabricated identically to example 1, except that yttrium oxide Y_2O_3 was used in place of europium oxide Eu_2O_3 in the fabrication of the sensor electrode 3.

Conditions in nitrogen oxide measurement

[0099] Nitrogen oxide measurement was conducted identically to example 1.

Sensing principles

[0100] As mentioned earlier, the nitrogen oxide sensor 10 of the present example was identical to example 1, except that yttrium oxide Y_2O_3 was used in place of europium oxide Eu_2O_3 to fabricate the sensor electrode 3.

[0101] Therefore, it would be safe to assume that the same reactions as in equations (1) to (7) discussed in example 1 took place except that Eu_2O_3 is replaced by Y_2O_3 in equation (1).

Sensing in dry atmosphere

[0102] Figure 9 is a response curve representing the electromotive force of the nitrogen oxide sensor 10 induced by the NO gas contained in dry measurement samples. As shown in the figure, The electromotive force (output) of the nitrogen oxide sensor 10 in a dry atmosphere monotonically increased with a decrease in the NO gas concentration and monotonically decreased with an increase in the NO gas concentration.

[0103] Referring to Figure 10, the reactions in the nitrogen oxide sensor 10 are reversible, because the electromotive force assumed reproducible values both in cases where the NO gas concentration increased (white circles) and where it decreased (black circles).

[0104] Still referring to the figure, electromotive forces were plotted against NO gas concentrations for dry samples, so as to determine the number of electrons transferred in the reaction, assigned n , in equation (7). Results showed $n = 0.91$ for both increasing and decreasing NO gas concentrations. Both values are very near the theoretical number of electrons transferred in the reaction ($n = 1.00$) calculated from equation (7). It is therefore understood that theoretical reactions were taking place in the nitrogen oxide sensor 10 both for dry and humid samples.

Example 3

[0105] The following will describe a nitrogen oxide sensor which is another example of the present invention, as well as the solid electrolyte, the oxide ion conductor, and the sensor electrode, in reference to Figure 1 and Figure 11 to Figure 12. Note that in the present example, $0.35\text{Gd}_2\text{O}_3\text{-}0.3\text{LiNO}_3$, which showed a maximum permittivity for $(1-x)/2\text{Gd}_2\text{O}_3\text{-}x\text{LiNO}_3$, was used as the sensor electrode; $(\text{Al}_{0.2}\text{Zr}_{0.8})_{20/19}\text{Nb}(\text{PO}_4)_3$ as the solid electrolyte (multivalent cation conductor) similarly to example 1; and $(\text{ZrO}_2)_{0.92}(\text{Y}_2\text{O}_3)_{0.08}$ as the oxide ion conductor.

Solid electrolyte and oxide ion conductor

[0106] The nitrogen oxide sensor of the present example is constructed as shown in the schematic of Figure 1. The solid electrolyte 1 and the oxide ion conductor 2, which were components of the nitrogen oxide sensor 10 of the present example, were fabricated identically to example 1.

Sensor electrode

5 **[0107]** The sensor electrode 3, which was a component of the nitrogen oxide sensor 10 of the present example, was fabricated identically to example 1, except that the europium oxide Eu_2O_3 in example 1 was replaced with gallium oxide Gd_2O_3 .

Nitrogen oxide sensor

10 **[0108]** The nitrogen oxide sensor 10 of the present example, as mentioned earlier, was fabricated identically to example 1, except that gallium oxide Gd_2O_3 and lithium nitrate LiNO_3 were used in place of europium oxide Eu_2O_3 and potassium nitrite KNO_2 respectively at $\text{Gd}_2\text{O}_3:\text{LiNO}_3 = 0.35:0.3$ in the fabrication of the sensor electrode 3.

Conditions in nitrogen oxide measurement

15 **[0109]** Nitrogen oxide measurement was conducted identically to example 1.

Sensing principles

20 **[0110]** As mentioned earlier, the nitrogen oxide sensor 10 of the present example was identical to example 1, except that gallium oxide Gd_2O_3 and lithium nitrate LiNO_3 were used in place of europium oxide Eu_2O_3 and potassium nitrite KNO_2 to fabricate the sensor electrode 3.

Sensing in dry atmosphere

25 **[0111]** Figure 11 is a response curve representing the electromotive force of the nitrogen oxide sensor 10 induced by the NO gas contained in dry measurement samples. As shown in the figure, the electromotive force (output) of the nitrogen oxide sensor 10 in a dry atmosphere monotonically increased with a decrease in the NO gas concentration and monotonically decreased with an increase in the NO gas concentration. The response time was as short as about 10 minutes.

30 **[0112]** Referring to Figure 12, the reactions in the nitrogen oxide sensor 10 are reversible, because the electromotive force assumed reproducible values both in cases where the NO gas concentration increased (white squares) and where it decreased (black circles) (good one-to-one correspondence observable between the electromotive forces and the logarithms of the NO gas concentrations).

35 **[0113]** Still referring to the figure, electromotive forces were plotted against NO gas concentrations for dry measurement sample, so as to determine the number of electrons transferred in the reaction, assigned n , in equation (7). Results showed $n = 2.77$ for increasing NO gas concentrations and $n = 2.51$ for decreasing NO gas concentrations. Both values differed by great amounts from the theoretical number of electrons transferred in the reaction calculated from equation (7) ($n = 1.00$; see a slant line in the figure) by great amounts.

Example 4

40 **[0114]** The following will describe a nitrogen oxide sensor which is another example of the present invention, as well as the solid electrolyte, the oxide ion conductor, and the sensor electrode, in reference to Figure 1 and Figure 13 to Figure 14. Note that the present example, $0.35\text{Gd}_2\text{O}_3\text{-}0.3\text{KNO}_2$, which showed a maximum permittivity, was used as the sensor electrode; $(\text{Al}_{0.2}\text{Zr}_{0.8})_{20/19}\text{Nb}(\text{PO}_4)_3$ as the solid electrolyte (multivalent cation conductor) similarly to example 1; and $(\text{ZrO}_2)_{0.92}(\text{Y}_2\text{O}_3)_{0.08}$ as the oxide ion conductor. Note also that in the present example, a NO gas (example 4-1), a NO_2 gas (example 4-2), and a NO/ NO_2 gas mixture (example 4-3) were used as the nitrogen oxide.

Example 4-1

Solid electrolyte and oxide ion conductor

50 **[0115]** The nitrogen oxide sensor of the present example is constructed as shown in the schematic of Figure 1. The solid electrolyte 1 and the oxide ion conductor 2, which were components of the nitrogen oxide sensor 10 of the present example, were fabricated identically to example 1.

Sensor electrode

5 **[0116]** The sensor electrode 3, which was a component of the nitrogen oxide sensor 10 of the present example, was fabricated identically to example 1, except that the europium oxide Eu_2O_3 in example 1 was replaced with gallium oxide Gd_2O_3 .

Nitrogen oxide sensor

10 **[0117]** The nitrogen oxide sensor 10 of the present example, as mentioned earlier, was fabricated identically to example 1, except that gallium oxide Gd_2O_3 was used in place of europium oxide Eu_2O_3 in the fabrication of the sensor electrode 3.

Conditions in nitrogen oxide measurement

15 **[0118]** Nitrogen oxide measurement was conducted identically to example 1.

Sensing principles

20 **[0119]** As mentioned earlier, the nitrogen oxide sensor 10 of the present example was almost identical to example 1, except that gallium oxide Gd_2O_3 was used in place of europium oxide Eu_2O_3 to fabricate the sensor electrode 3.

[0120] Therefore, it would be safe to assume that almost the same reactions as in equations (1) to (7) discussed in example 1 took place except that Eu_2O_3 is replaced by Gd_2O_3 in equation (1).

Sensing in dry atmosphere

25 **[0121]** Figure 13 is a response curve representing the electromotive force of the nitrogen oxide sensor 10 induced by the NO gas contained in dry measurement samples. As shown in the figure, the electromotive force (output) of the nitrogen oxide sensor 10 in a dry atmosphere monotonically decreased with an increase in the NO gas concentration and monotonically increased with a decrease in the NO gas concentration. The response time was as short as 7 minutes to 10 minutes.

30 **[0122]** Referring to Figure 14, the reactions in the nitrogen oxide sensor 10 are reversible, because the electromotive force assumed reproducible values both in cases where the NO gas concentration increased (white squares) and where it decreased (black circles) (good one-to-one correspondence observable between the electromotive forces and the logarithms of the NO gas concentrations).

35 **[0123]** Still referring to the figure, electromotive forces were plotted against NO gas concentrations for dry samples, so as to determine the number of electrons transferred in the reaction, assigned n , in equation (7). Results showed $n = 1.03$ for increasing NO gas concentrations and $n = 1.01$ for decreasing NO gas concentrations. Both values well fit the theoretical number of electrons transferred in the reaction calculated from equation (7) ($n = 1.00$; see a slant line in the figure).

40 **[0124]** Thus, the present example demonstrated that the NO gas concentration was accurately measured through the measurement of the sensor output.

Example 4-2

NO₂ gas measurement

45 **[0125]** Measurement was conducted on a NO₂ gas as the nitrogen oxide, similarly to the measurement on a NO gas in example 4-1.

Sensing in dry atmosphere

50 **[0126]** Figure 15 is a response curve representing the electromotive force of the nitrogen oxide sensor 10 induced by the NO₂ gas contained in dry measurement samples. As shown in the figure, the electromotive force (output) of the nitrogen oxide sensor 10 in a dry atmosphere monotonically increased with a decrease in the NO₂ gas concentration and monotonically decreased with an increase in the NO gas concentration. The response time was from 10 minutes to 30 minutes. The electromotive force decreased with an increase in the concentration. Conversely, when the concentration was changed back to its original value, the sensor output returned practically to its original value. This confirms that the NO₂ gas concentration can be measured reversibly, similarly to the case of a NO gas concentration.

55 **[0127]** Referring to Figure 16, the reactions in the nitrogen oxide sensor 10 are reversible, because the electromotive

force assumed reproducible values both in cases where the NO₂ gas concentration increased (white squares) and where it decreased (black circles) (good one-to-one correspondence observable between the electromotive forces and the logarithms of the NO₂ gas concentrations).

[0128] Still referring to the figure, electromotive forces were plotted against NO gas concentrations for dry samples, so as to determine the number of electrons transferred in the reaction, assigned n , in equation (7). Results showed $n = 1.01$ for increasing NO₂ gas concentrations and $n = 1.00$ for decreasing NO₂ gas concentrations. Both values well fit the theoretical number of electrons transferred in the reaction calculated from equation (7) ($n = 1.00$, see a slant line in the figure).

[0129] Thus, the present example demonstrated that the NO₂ gas concentration was accurately measured through the measurement of the sensor output.

Example 4-3

NO/NO₂ gas mixture measurement

[0130] Figure 17 is a graph showing the NO_x gas concentration dependence of the electromotive force of the example 4 nitrogen oxide sensor. As shown in the figure, the electromotive force for the NO gas (black circles) and the electromotive force for the NO₂ gas (white squares) assumed almost equal values at the same concentration. This demonstrates that the nitrogen oxide sensor 10 of the present example can measure the NO_x concentration of a NO/NO₂ mixed gas system.

Sensing in dry atmosphere

[0131] Figure 18 is a response curve representing the electromotive force of the nitrogen oxide sensor 10 for the NO gas in dry measurement samples. The NO_x concentration was fixed at 2000 ppm, while the NO/NO₂ mix ratio was varied to take many different values. The electromotive force value differed from values indicated in Figures 13 and 15 for the 2000 ppm gas flow, because different batches were used from examples 4-1 and 4-2. However, the electromotive force does not vary with a change in the NO/NO₂ mix ratio. This confirms that the nitrogen oxide sensor 10 can measure the NO_x concentration of a NO/NO₂ mixed gas system.

[0132] The foregoing description has clearly shown that the nitrogen oxide sensor, including 0.35Gd₂O₃-0.3KNO₂ as the sensor electrode, (Al_{0.2}Zr_{0.8})_{20/19}Nb(PO₄)₃ as the solid electrolyte, and (ZrO₂)_{0.92}(Y₂O₃)_{0.08} as the oxide ion conductor, has sufficiently sensor capability for NO_x gas leaking into the atmosphere in industrial facilities, for example. In addition, with a nitrite as the sensor electrode, the sensor exhibits electromotive force dependence of its NO_x gas concentration which matches well with theoretical values, which demonstrates that the nitrogen oxide concentration can be accurately measured through the sensor's electromotive force. Further, with the nitrite sensor electrode, the sensor's electromotive force takes practically equal values at equal gas concentrations regardless of whether the nitrogen oxide concentration is being varied in increasing or decreasing direction. Thus, the NO_x concentration can be measured quickly and in a reversible manner.

INDUSTRIAL APPLICABILITY

[0133] As detailed in the foregoing, the nitrogen oxide sensor in accordance with the present invention electrode contains a solid solution of a nitrate or nitrite of an alkali metal and an oxide of a rare-earth element.

[0134] Therefore, the sensor electrode is highly water-insoluble and suitable to nitrogen oxide sensing, especially, in a humid atmosphere containing water vapor. When the sensor electrode is incorporated, for example, in a nitrogen oxide sensor based on a solid electrolyte, the nitrogen oxide sensor comes to exhibit highly practical features, especially nitrogen oxide sensing capability with good responsiveness in a humid atmosphere containing water vapor.

[0135] The nitrogen oxide sensor in accordance with the present invention contains the sensor electrode, the solid electrolyte, and the oxide ion conductor. The sensor electrode and the oxide ion conductor are provided in contact with a surface of the solid electrolyte. The solid electrolyte conducts magnesium ions, aluminum ions, rare earth ions, zirconium ions, or hafnium ions.

[0136] Therefore, the nitrogen oxide sensor exhibits highly practical features, especially high water-insolubility and suitability to the measurement of nitrogen oxides in a humid atmosphere containing water vapor.

Claims

1. A nitrogen oxide sensor electrode, **characterized by** comprising: a solid solution of a nitrate or nitrite of an alkali metal; and an oxide of a rare-earth element.

EP 1 498 728 B1

2. The nitrogen oxide sensor electrode as set forth in claim 1, wherein said oxide is Eu_2O_3 , Y_2O_3 , or Gd_2O_3 .
3. The nitrogen oxide sensor electrode as set forth in either claim 1 or 2, wherein said nitrate or nitrite is a nitrite of an alkali metal.
- 5 4. The nitrogen oxide sensor electrode as set forth in claim 3, wherein said nitrite is KNO_2 .
- 10 5. A nitrogen oxide sensor, **characterized by** comprising: the nitrogen oxide sensor electrode as set forth in any one of claims 1 to 4; a solid electrolyte; and an oxide ion conductor, wherein:
 - the nitrogen oxide sensor electrode and the oxide ion conductor are provided in contact with a surface of the solid electrolyte; and
 - the solid electrolyte conducts magnesium ions, aluminum ions, rare earth ions, zirconium ions, or hafnium ions.
- 15 6. The nitrogen oxide sensor as set forth in claim 5, wherein the solid electrolyte is sandwiched between the nitrogen oxide sensor electrode and the oxide ion conductor.
7. The nitrogen oxide sensor as set forth in either one of claims 5 and 6, wherein the solid electrolyte has a Nasicon or β -iron sulfate crystal structure.
- 20 8. The nitrogen oxide sensor as set forth in claim 7, wherein the solid electrolyte is a complex of $\text{Mg}_{1+X}\text{Zr}_4\text{P}_6\text{O}_{24+X}$ ($0 < X \leq 0.4$) and $\text{Zr}_2\text{O}(\text{PO}_4)_2$ or a solid solution, $\text{Mg}_{1-2Y}(\text{Zr}_{1-Y}\text{Nb}_Y)_4\text{P}_6\text{O}_{24}$ ($0 \leq Y < 1/2$), conducting magnesium ions.
- 25 9. The nitrogen oxide sensor as set forth in claim 7, wherein the solid electrolyte has a composition, $(\text{Al}_{0.2}\text{Zr}_{0.8})_{20/19}\text{Nb}(\text{PO}_4)_3$, conducting aluminum ions.
10. The nitrogen oxide sensor as set forth in claim 7, wherein the solid electrolyte has a composition, $\text{R}_{1/3}\text{Zr}_2(\text{PO}_4)_3$, conducting rare earth ions, where R is a rare earth atom.
- 30 11. The nitrogen oxide sensor as set forth in claim 7, wherein the solid electrolyte has a composition, $\text{ZrNb}(\text{PO}_4)_3$, conducting zirconium ions.
12. The nitrogen oxide sensor as set forth in claim 7, wherein the solid electrolyte has a composition, $\text{HfNb}(\text{PO}_4)_3$, conducting hafnium ions.
- 35 13. The nitrogen oxide sensor as set forth in any one of claims 5 to 11, wherein the oxide ion conductor is made of at least one of the group consisting of fully stabilized zirconia, cerium oxide, bismuth oxide, hafnium oxide, thorium oxide, and lanthanum gallate.
- 40 14. The nitrogen oxide sensor as set forth in any one of claims 5 to 13, wherein the solid electrolyte is 0.1 mm to 1.5 mm thick.
15. The nitrogen oxide sensor as set forth in any one of claims 5 to 14, wherein the oxide ion conductor is 0.1 mm to 1.5 mm thick.
- 45 16. The nitrogen oxide sensor as set forth in any one of claims 5 to 15, wherein the nitrogen oxide sensor electrode is of a board shape and 0.1 mm to 1.5 mm thick.

50 Patentansprüche

1. Elektrode für einen Stickstoffsensoren, **dadurch gekennzeichnet, dass** dieser umfasst: eine feste Lösung eines Nitrats oder Nitrids eines Alkalimetalls; und ein Oxid eines Salten-Erdelemente.
- 55 2. Elektrode für einen Stickstoffsensoren nach Anspruch 1, wobei das Oxid Eu_2O_3 , Y_2O_3 oder Gd_2O_3 entspricht.
3. Elektrode für einen Stickstoffsensoren nach einem der Ansprüche 1 oder 2, wobei das Nitrat oder Nitrid ein Nitrid eines Alkalimetalls ist.

EP 1 498 728 B1

4. Elektrode für einen Stickstoffsensoren nach Anspruch 3, wobei das Nitrid KNO_2 ist.
5. Stickstoffoxidsensoren, **dadurch gekennzeichnet, dass** dieser umfasst; die Elektrode für einen Stickstoffsensoren nach einem der Ansprüche 1 bis 4; einen festen Elektrolyten; einen Oxidionenleiter, wobei:

die Elektrode für einen Stickstoffoxidsensoren und der Oxidionenleiter in Kontakt mit einer Oberfläche des festen Elektrolyten sind; und
der feste Elektrolyt Magnesiumionen, Aluminiumionen, Selten-Erdionen. Zirkoniumionen oder Hafniumionen leitet.

6. Stickstoffoxidsensoren nach Anspruch 5, wobei der Elektrolyt zwischen die Elektrode für einen Stickstoffoxidsensoren und den Oxidionenleiter eingelegt ist.
7. Stickstoffoxidsensoren nach einem der Ansprüche 5 und 6, wobei der feste Elektrolyt eine Nasicon- oder β -Eisen-Sulfatkristallstruktur aufweist.
8. Stickstoffoxidsensoren nach Anspruch 7, wobei der Elektrolyt einen Komplex aus $\text{Mg}_{1+x}\text{Zr}_4\text{P}_6\text{O}_{24+x}$ ($0 < x < 0.4$) und $\text{Zr}_2\text{O}(\text{PO}_4)_2$ oder einer festen Lösung, $\text{Mg}_{1-2y}(\text{Zr}_{1-y}\text{Nb}_y)_4\text{P}_6\text{O}_{24}$ ($0 \leq y < 1/2$), leitenden Magnesiumionen darstellt.
9. Stickstoffoxidsensoren nach Anspruch 7, wobei der feste Elektrolyt eine Zusammensetzung aus $(\text{Al}_{0.2}\text{Zr}_{0.8})_{20/19}\text{Nb}(\text{PO}_4)_3$, leitenden Aluminiumionen aufweist.
10. Stickstoffoxidsensoren nach Anspruch 7, wobei der feste Elektrolyt eine Zusammensetzung aus $\text{R}_{1/3}\text{Zr}_2(\text{PO}_4)_3$, leitenden Selten-Erdionen aufweist, wobei R ein Selten-Erdatom ist.
11. Stickstoffoxidsensoren nach Anspruch 7, wobei der feste Elektrolyt eine Zusammensetzung aus $\text{ZrNb}(\text{PO}_4)_3$, leitenden Zirkoniumionen aufweist.
12. Stickstoffoxidsensoren nach Anspruch 7, wobei der feste Elektrolyt eine Zusammensetzung aus $\text{HfNb}(\text{PO}_4)_3$, leitenden Hafniumionen aufweist.
13. Stickstoffoxidsensoren nach einem der Ansprüche 5 bis 11, wobei der Oxidionenleiter aus wenigstens einem Element der Gruppe bestehend aus vollständig stabilisiertem Zirkonoxid, Ceroxid, Wismutoxid, Hafniumoxid und Lanthan-gallat besteht.
14. Stickstoffoxidsensoren nach einem der Ansprüche 5 bis 13, wobei der feste Elektrolyt 0.1 nm bis 1.5 nm dick ist.
15. Stickstoffoxidsensoren nach einem der Ansprüche 5 bis 14, wobei der Oxidionenleiter 0.1 nm bis 1.5 nm dick ist.
16. Stickstoffoxidsensoren nach einem der Ansprüche 5 bis 15, wobei die Elektrode für den Stickstoffoxidsensoren eine Plattenform aufweist und 0.1 nm bis 1,5 nm dick ist.

Revendications

1. Électrode de détection d'oxyde d'azote, **caractérisée en ce qu'**elle comprend : une solution solide d'un nitrate ou d'un nitrite d'un métal alcalin ; et un oxyde d'un élément de terre rare.
2. Électrode de détection d'oxyde d'azote selon la revendication 1, dans laquelle ledit oxyde est Eu_2O_3 , Y_2O_3 ou Gd_2O_3 .
3. Électrode de détection d'oxyde d'azote selon la revendication 1 ou la revendication 2, dans laquelle ledit nitrate ou nitrite est un nitrite d'un métal alcalin.
4. Électrode de détection d'oxyde d'azote selon la revendication 3, dans laquelle ledit nitrite est KNO_2 .
5. Détecteur d'oxyde d'azote, **caractérisée en ce qu'**il comprend : l'électrode de détection d'oxyde d'azote selon l'une quelconque des revendications 1 à 4 ; un électrolyte solide ; et un oxyde conducteur ionique, dans lequel :

EP 1 498 728 B1

l'électrode de détection d'oxyde d'azote et l'oxyde conducteur ionique sont mis en contact avec une surface de l'électrolyte solide ; et
l'électrolyte solide conduit des ions magnésium, des ions aluminium, des ions de terres rares, des ions zirconium ou des ions hafnium.

- 5
6. Détecteur d'oxyde d'azote selon la revendication 5, dans lequel l'électrolyte solide est pris en sandwich entre l'électrode de détection d'oxyde d'azote et l'oxyde conducteur ionique.
- 10
7. Détecteur d'oxyde d'azote selon la revendication 5 ou la revendication 6, dans lequel l'électrolyte solide a une structure cristalline Nasicon ou sulfate de fer β .
- 15
8. Détecteur d'oxyde d'azote selon la revendication 7, dans lequel l'électrolyte solide est un complexe de $Mg_{1+x}Zr_4P_6O_{24+x}$ ($0 < X \leq 0,4$) et $Zr_2O(PO_4)_2$ ou une solution solide, $Mg_{1-2Y}(Zr_{1-Y}Nb_Y)_4P_6O_{24}$ ($0 \leq Y < 1/2$), conduisant les ions magnésium.
- 20
9. Détecteur d'oxyde d'azote selon la revendication 7, dans lequel l'électrolyte solide a une composition, $(Al_{0,2}Zr_{0,8})_{20/19}Nb(PO_4)_3$, conduisant les ions magnésium.
- 25
10. Détecteur d'oxyde d'azote selon la revendication 7, dans lequel l'électrolyte solide a une composition, $R_{1/3}Zr_2(PO_4)_3$, conduisant les ions de terres rares, où R est un atome de terre rare.
- 30
11. Détecteur d'oxyde d'azote selon la revendication 7, dans lequel l'électrolyte solide a une composition, $ZrNb(PO_4)_3$, conduisant les ions zirconium.
- 35
12. Détecteur d'oxyde d'azote selon la revendication 7, dans lequel l'électrolyte solide a une composition, $HfNb(PO_4)_3$, conduisant les ions hafnium.
- 40
13. Détecteur d'oxyde d'azote selon l'une quelconque des revendications 5 à 11, dans lequel l'oxyde conducteur ionique est constitué d'au moins un élément du groupe constitué de la zircone totalement stabilisée, de l'oxyde de cérium, de l'oxyde de bismuth, de l'oxyde de hafnium, de l'oxyde de thorium et du gallate de lanthane.
- 45
14. Détecteur d'oxyde d'azote selon l'une quelconque des revendications 5 à 13, dans lequel l'épaisseur de l'électrolyte solide va de 0,1 mm à 1,5 mm.
- 50
15. Détecteur d'oxyde d'azote selon l'une quelconque des revendications 5 à 14, dans lequel l'épaisseur de l'oxyde conducteur ionique va de 0,1 mm à 1,5 mm.
- 55
16. Détecteur d'oxyde d'azote selon l'une quelconque des revendications 5 à 15, dans lequel l'électrode de détection d'oxyde d'azote est en forme de plaque et dont l'épaisseur va de 0,1 mm à 1,5 mm.

FIG. 1

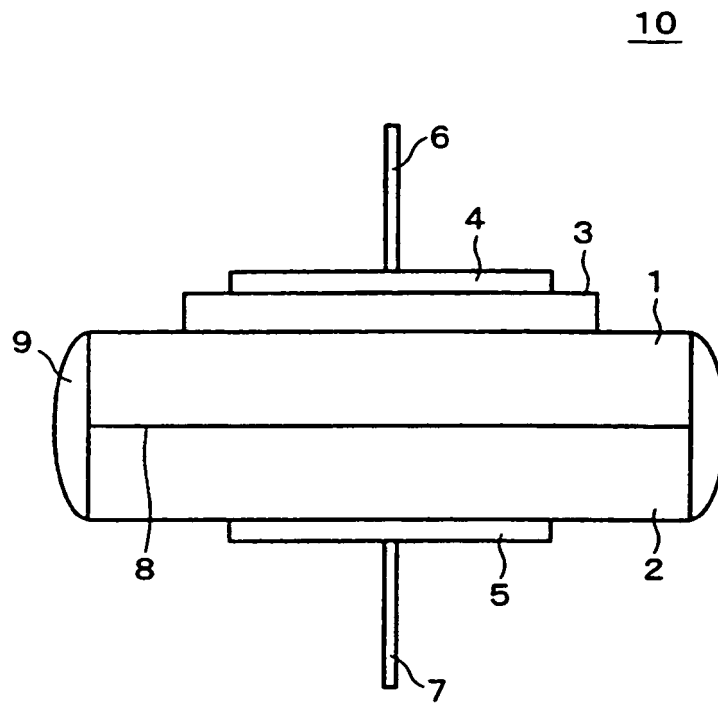

FIG. 2

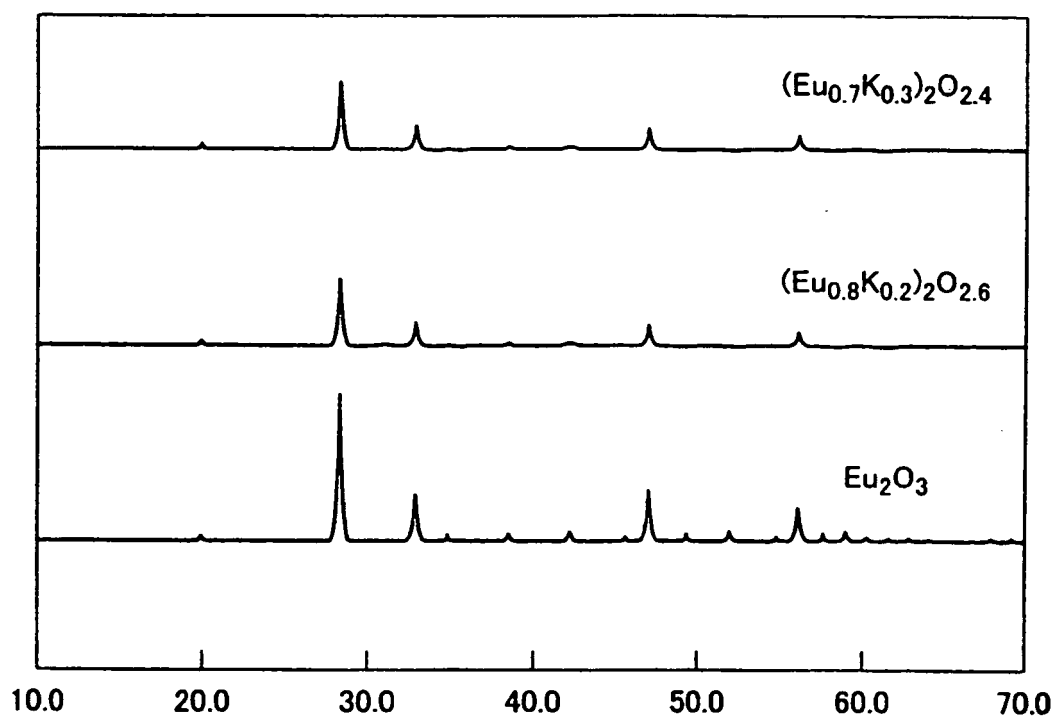

FIG. 3

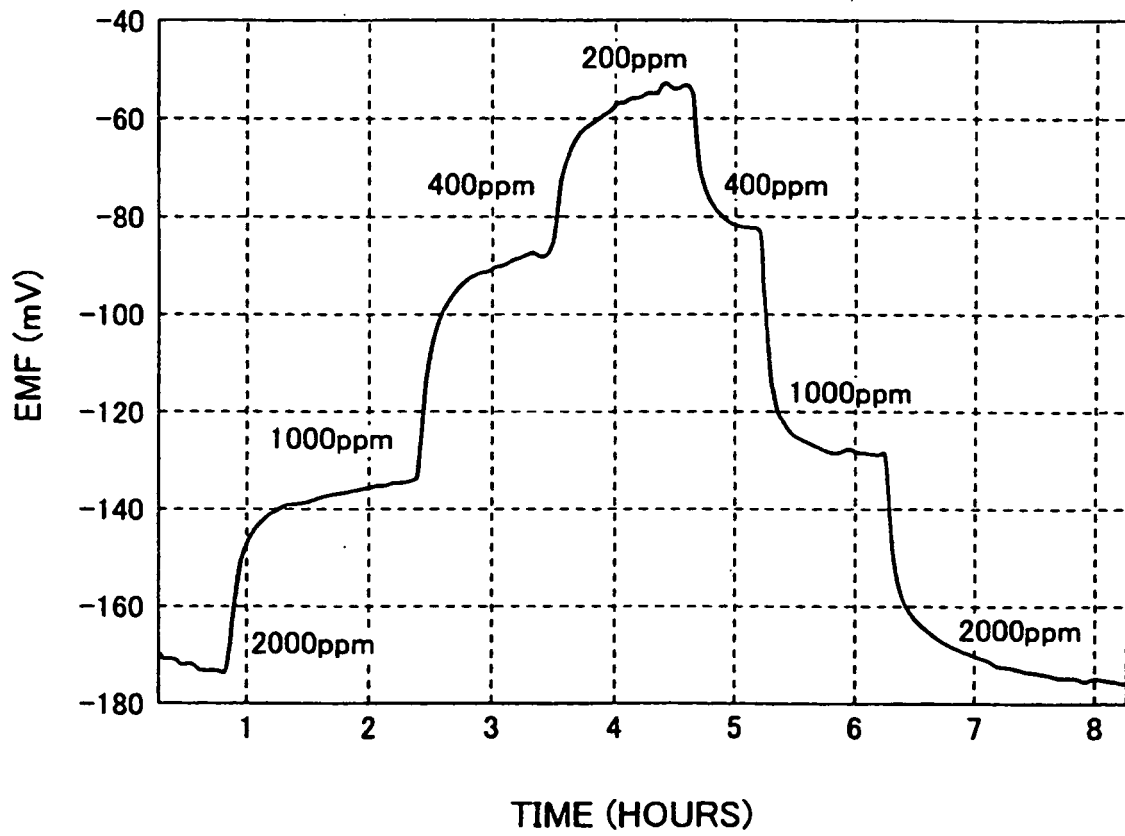

FIG. 4

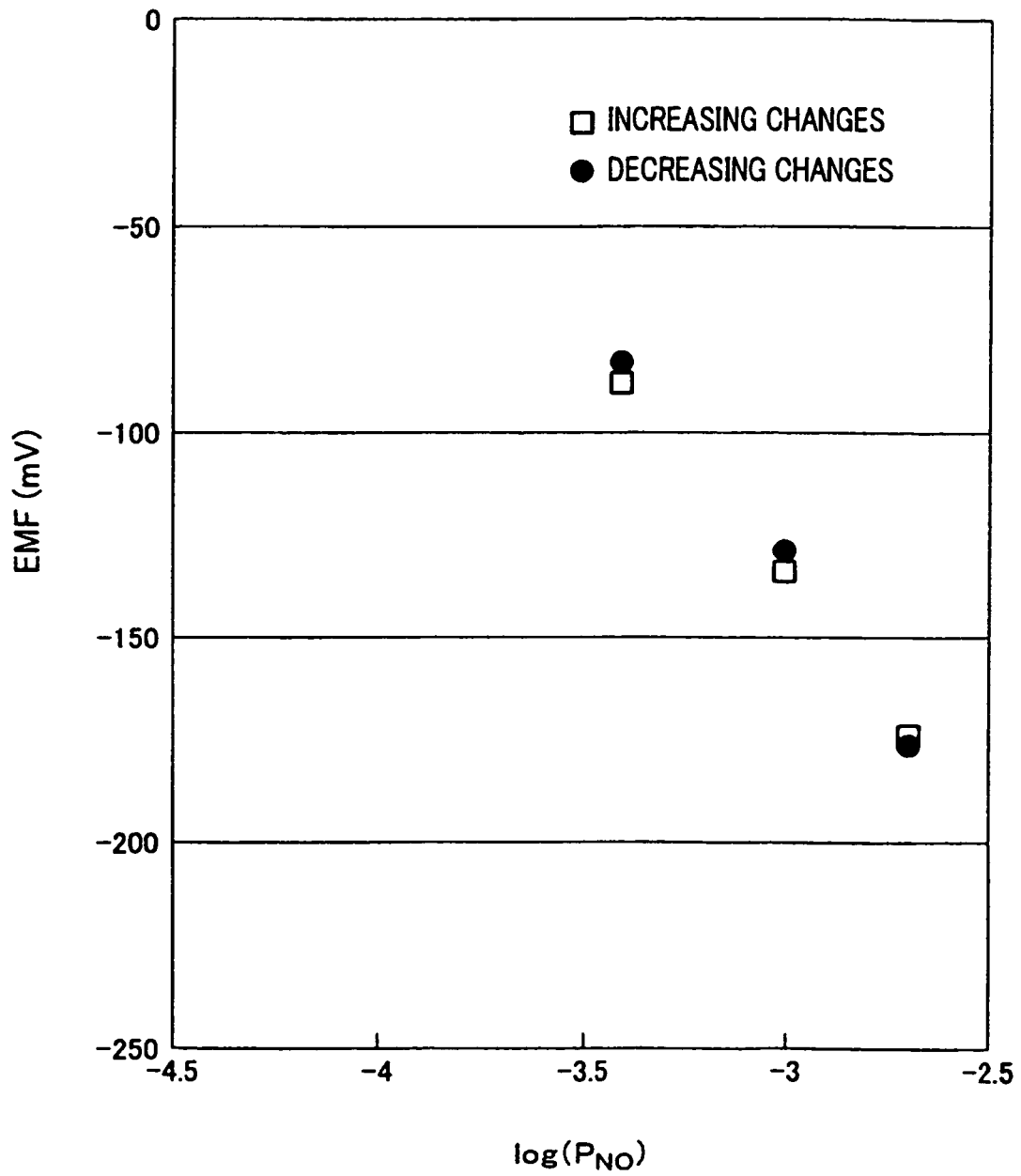

FIG. 5

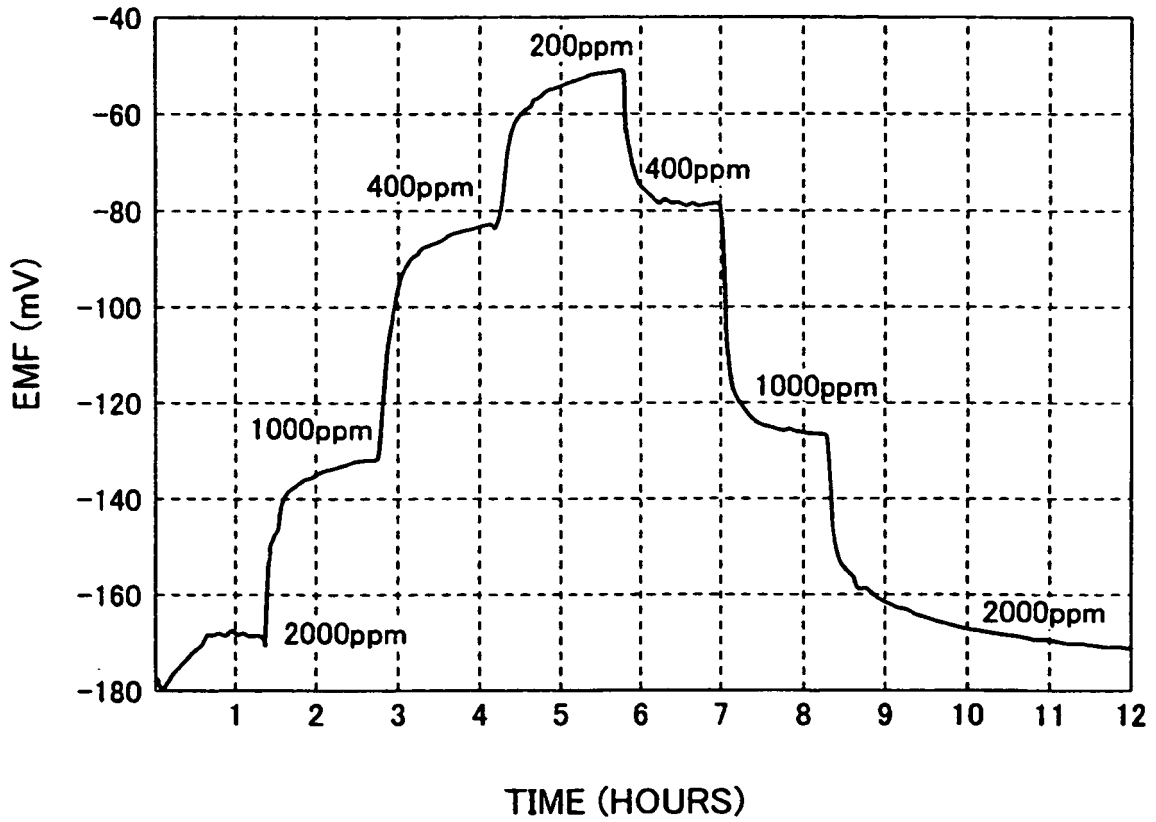

FIG. 6

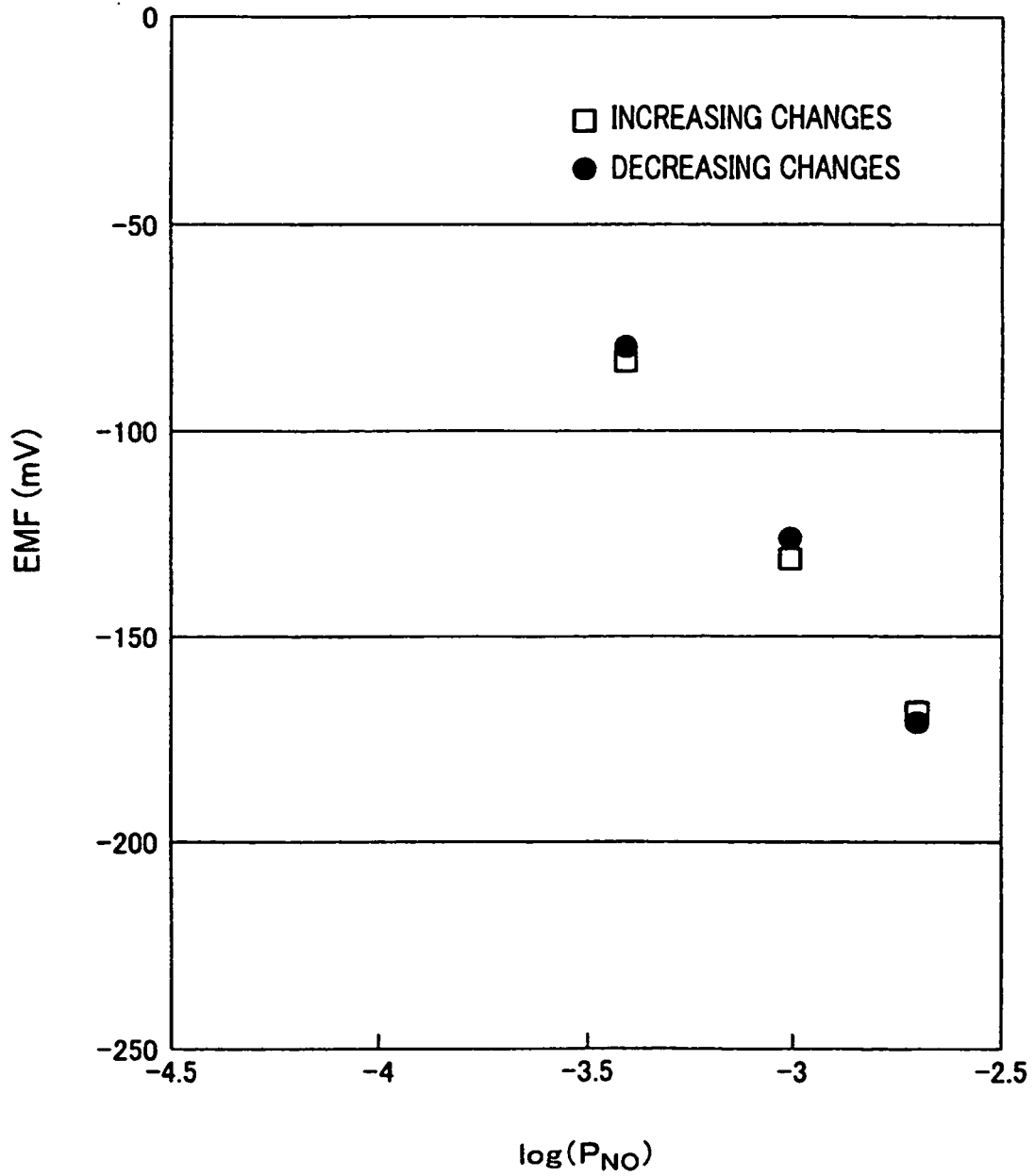

FIG. 7

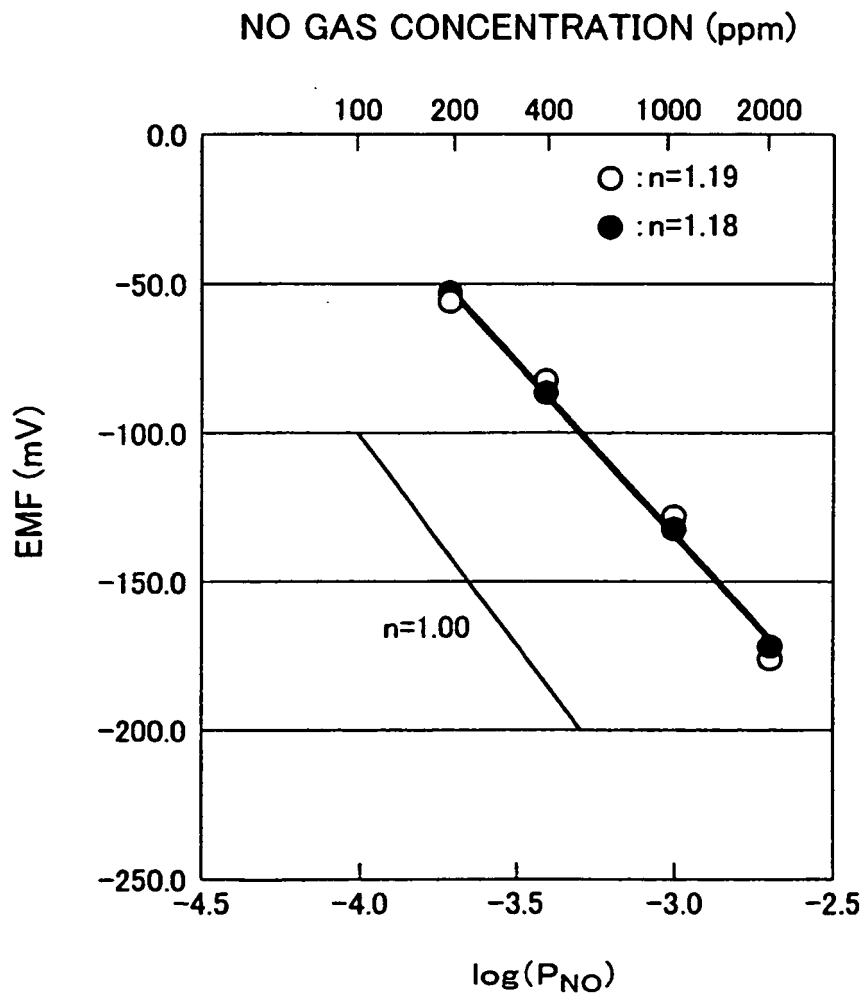

FIG. 8

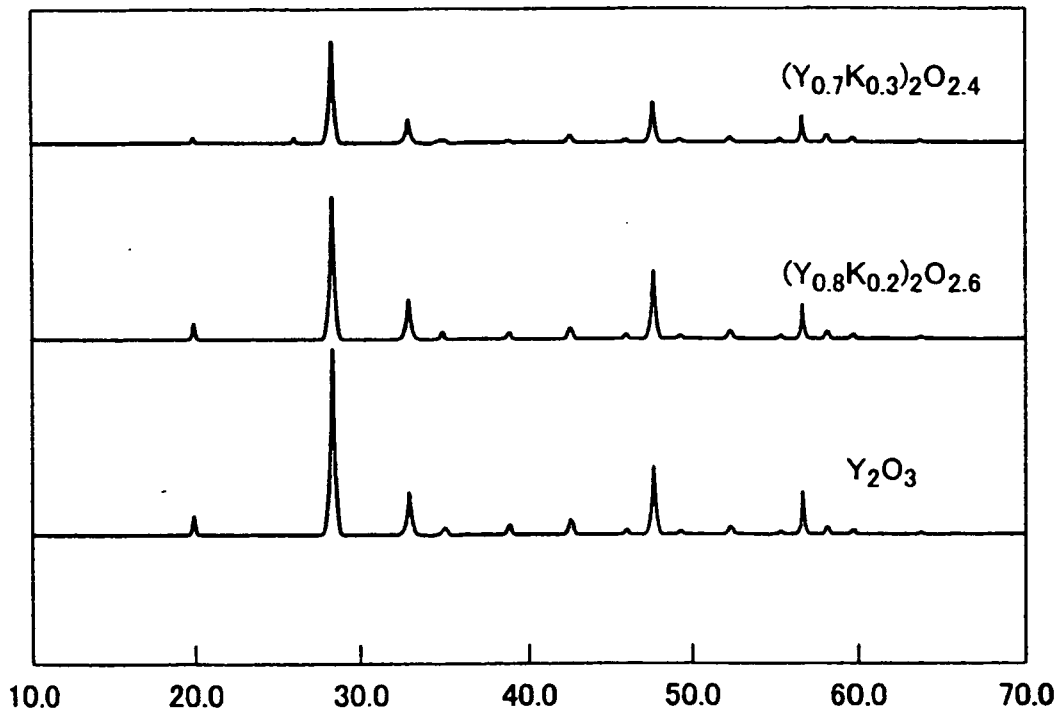

FIG. 9

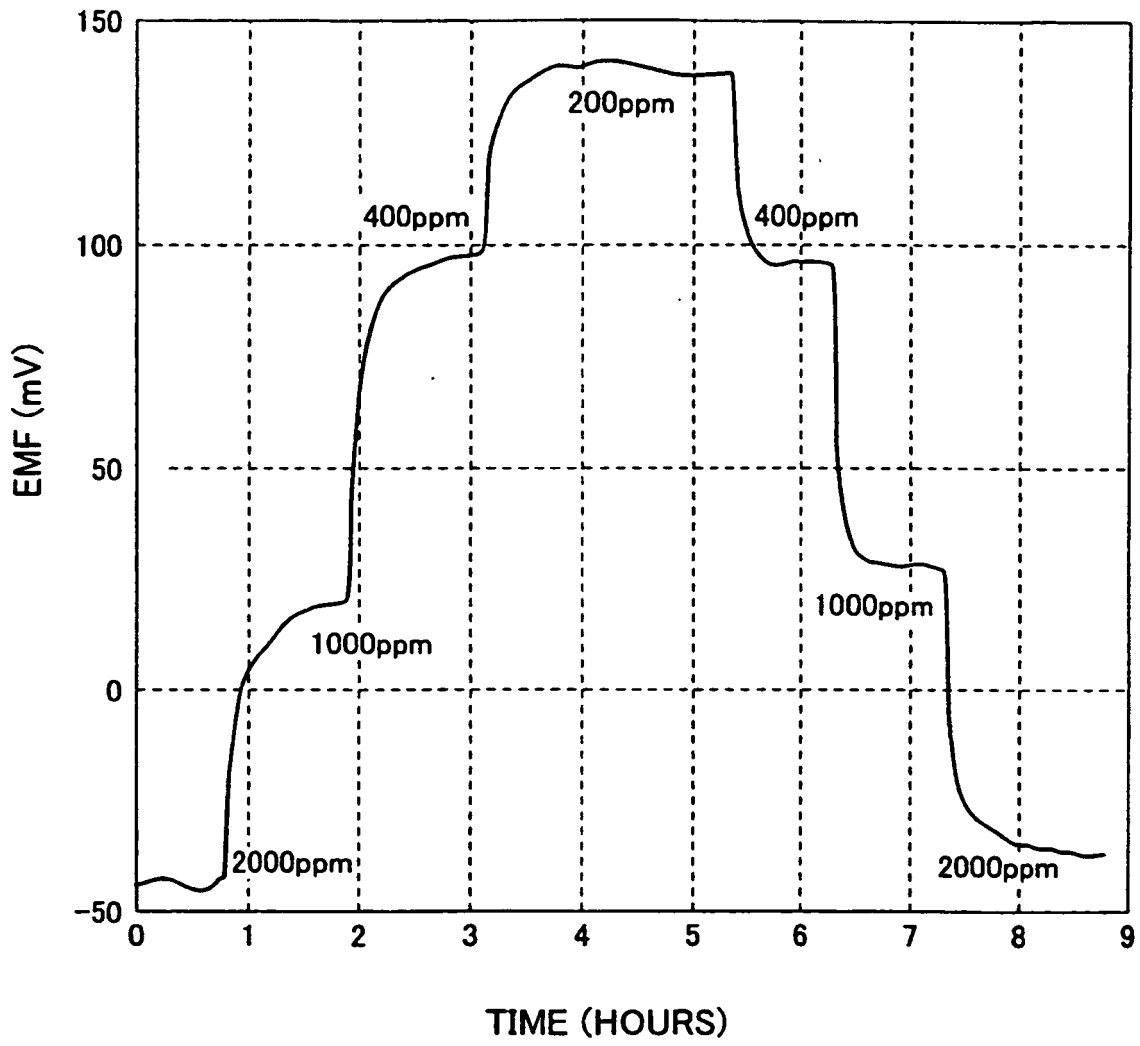

FIG. 10

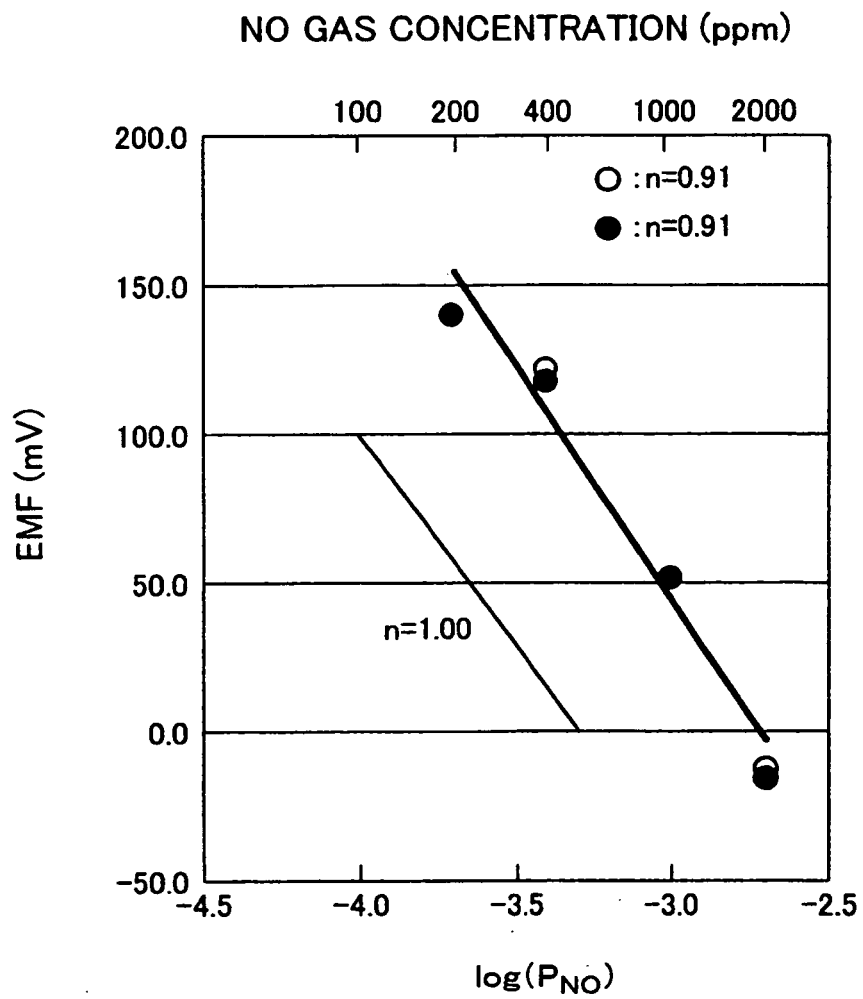

FIG. 11

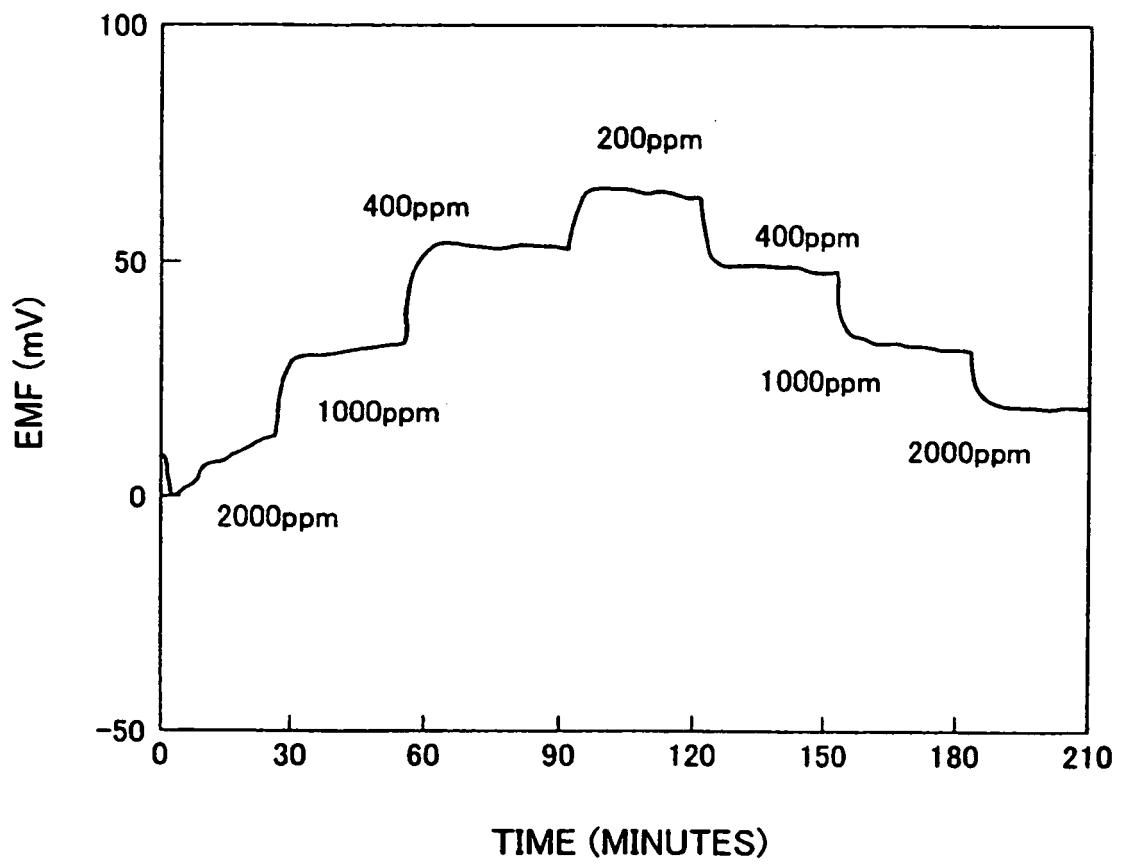

FIG. 12

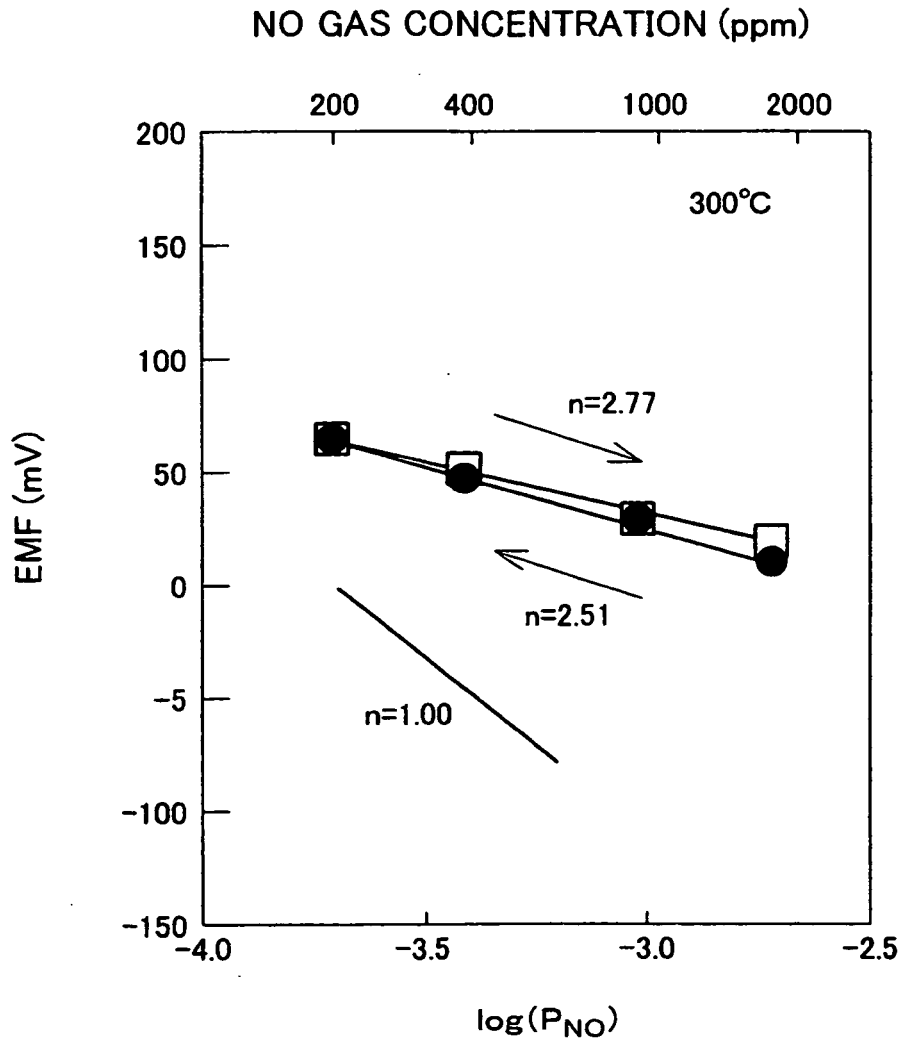

FIG. 13

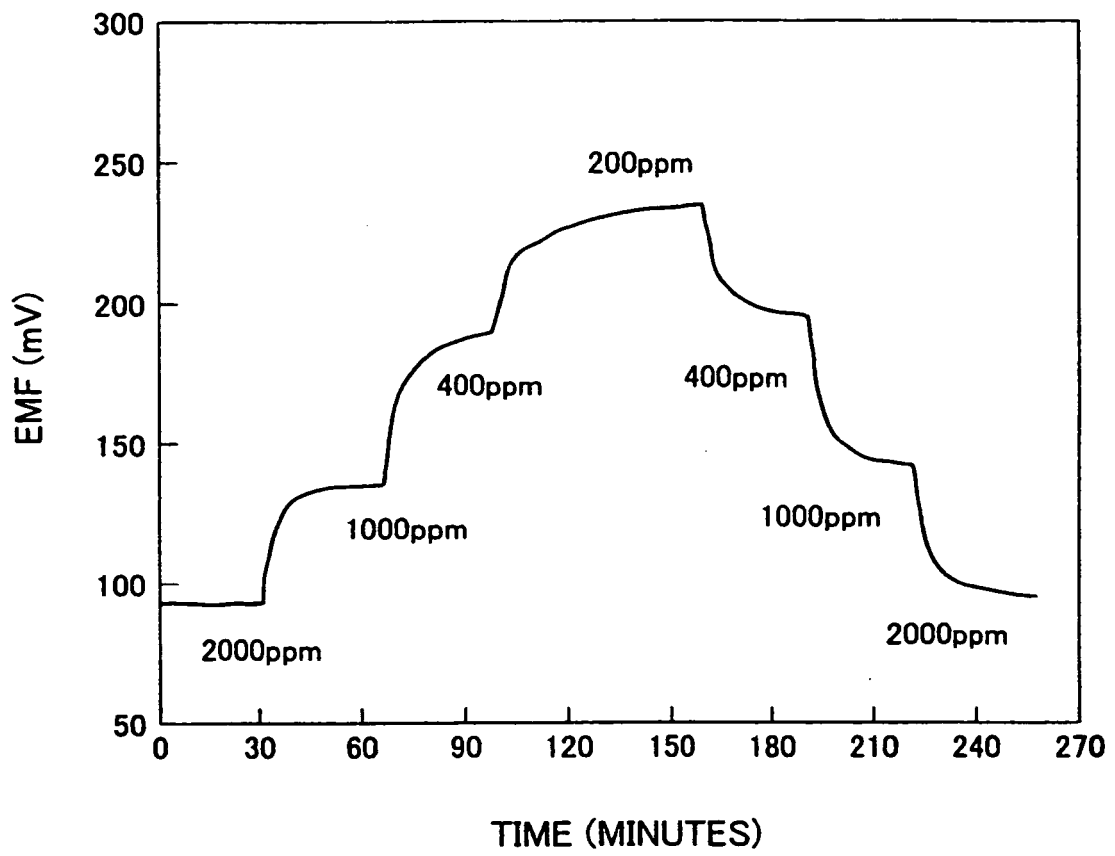

FIG. 14

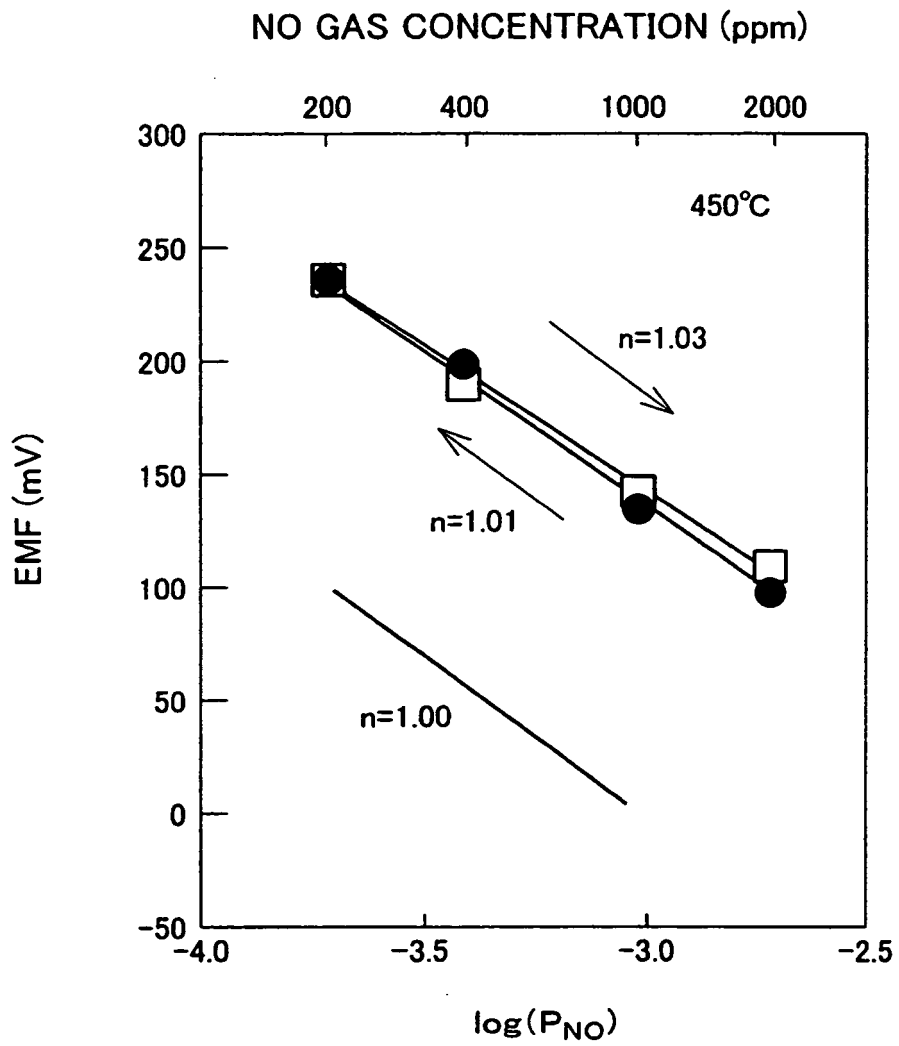

FIG. 15

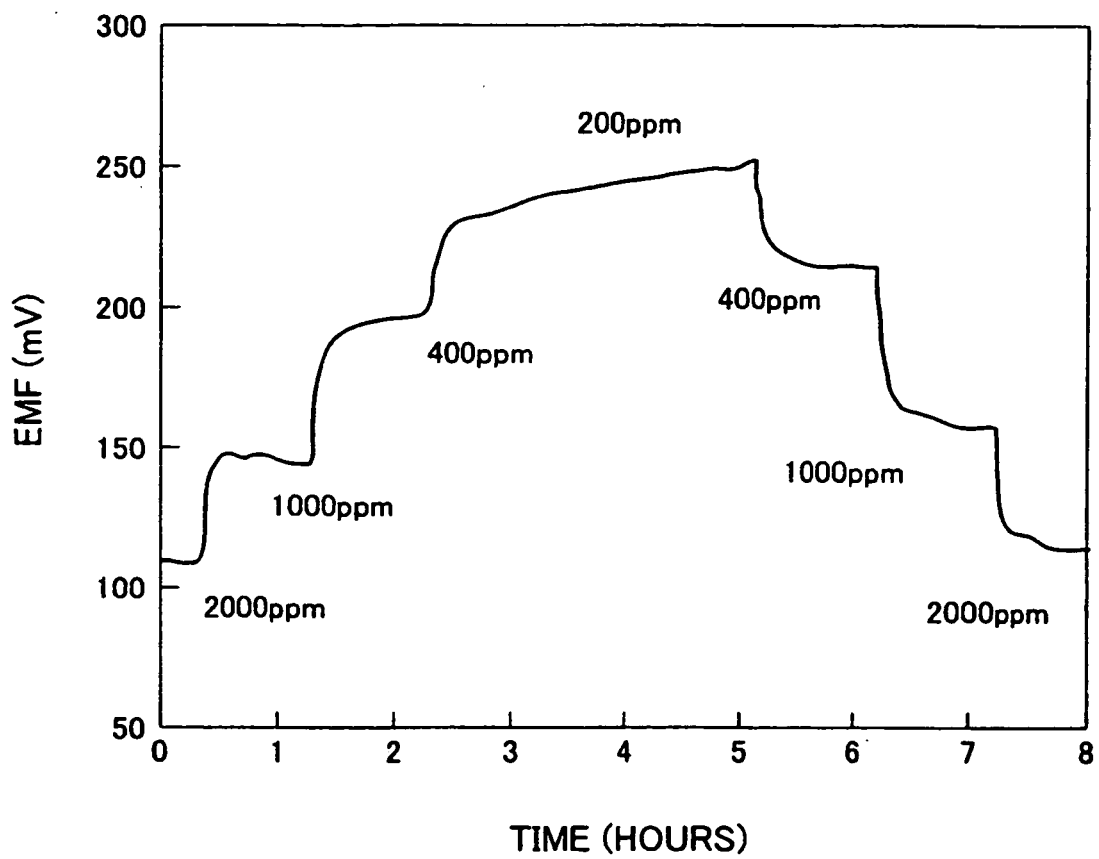

FIG. 16

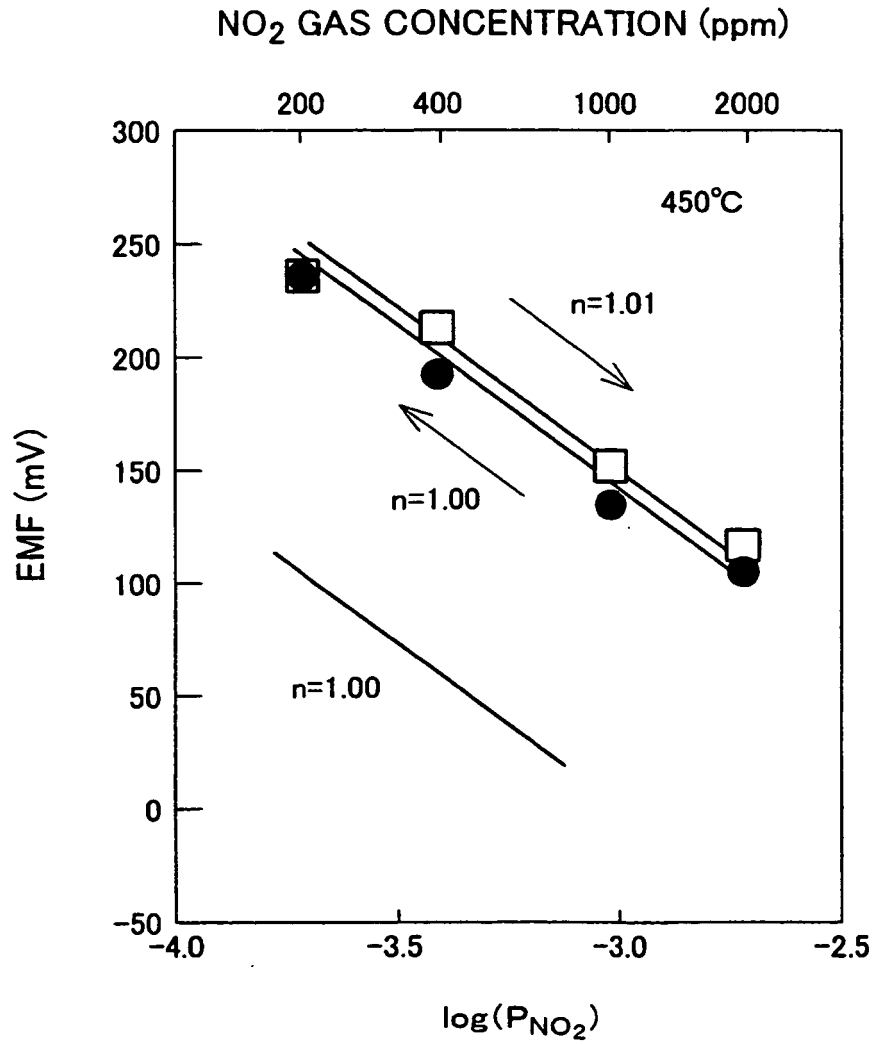

FIG. 17

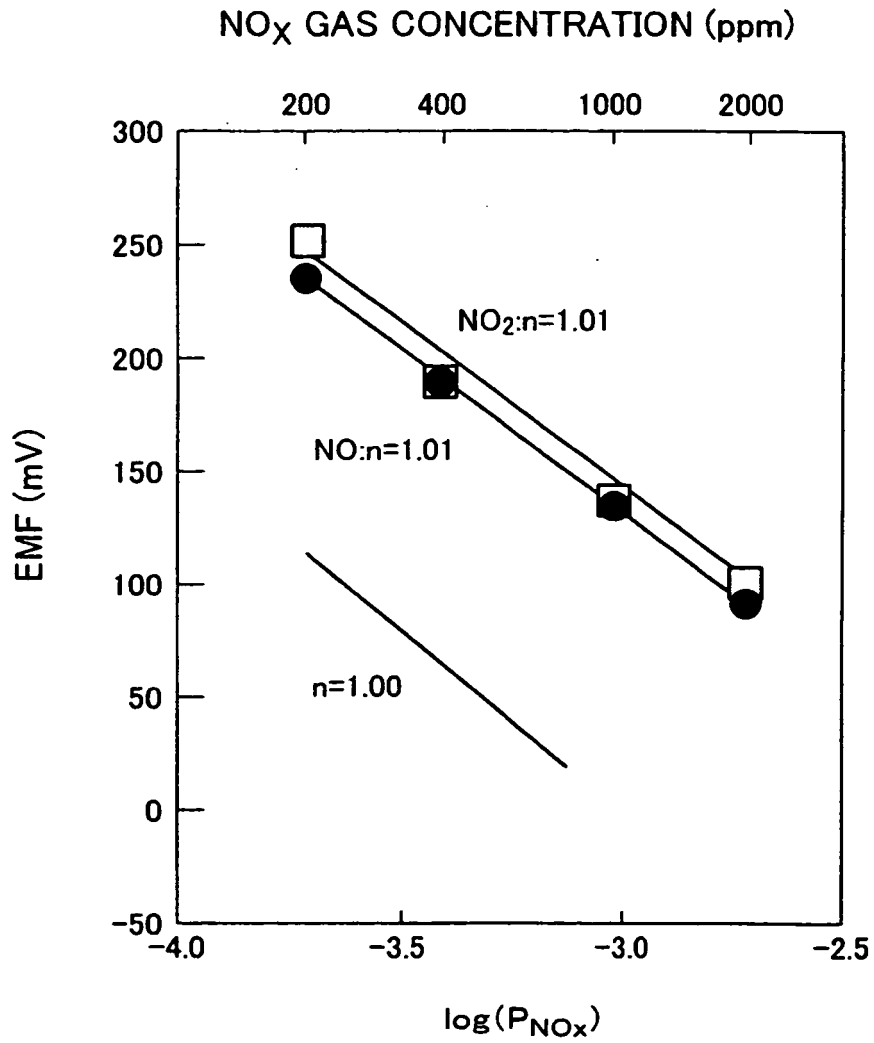
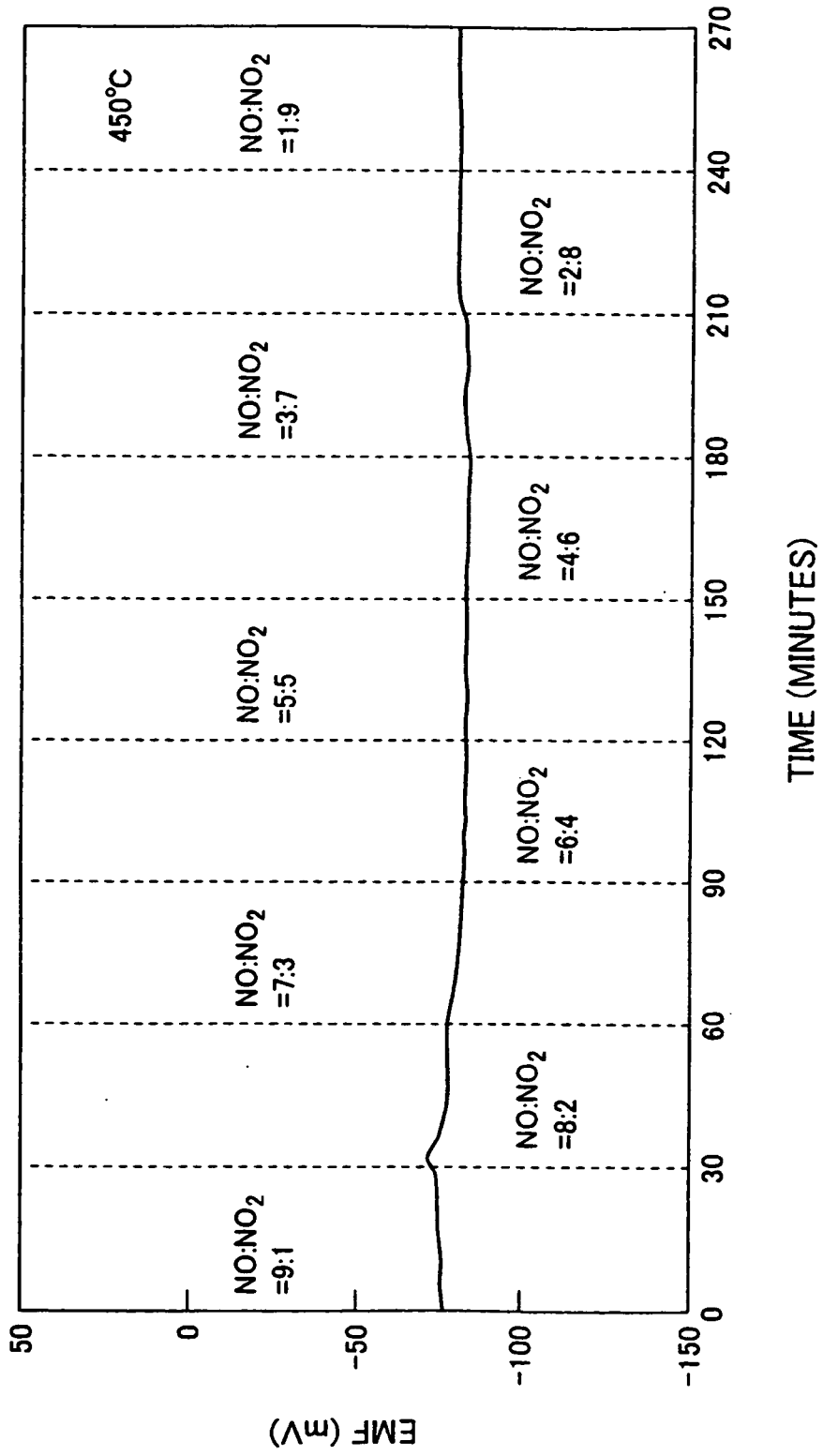

FIG. 18



REFERENCES CITED IN THE DESCRIPTION

This list of references cited by the applicant is for the reader's convenience only. It does not form part of the European patent document. Even though great care has been taken in compiling the references, errors or omissions cannot be excluded and the EPO disclaims all liability in this regard.

Patent documents cited in the description

- JP 2001133435 A [0009]