



US007956360B2

(12) **United States Patent**
Haskell et al.

(10) **Patent No.:** **US 7,956,360 B2**

(45) **Date of Patent:** **Jun. 7, 2011**

(54) **GROWTH OF PLANAR REDUCED DISLOCATION DENSITY M-PLANE GALLIUM NITRIDE BY HYDRIDE VAPOR PHASE EPITAXY**

(58) **Field of Classification Search** 438/481, 438/41, 48, 71, 479; 257/E21.097, E21.117, 257/64, 65, 78, 189, E29.003, E29.004, E33.025
See application file for complete search history.

(75) Inventors: **Benjamin A. Haskell**, Santa Barbara, CA (US); **Melvin B. McLaurin**, Goleta, CA (US); **Steven P. DenBaars**, Goleta, CA (US); **James Stephen Speck**, Goleta, CA (US); **Shuji Nakamura**, Santa Barbara, CA (US)

(56) **References Cited**

U.S. PATENT DOCUMENTS

5,290,393	A	3/1994	Nakamura
5,432,808	A	7/1995	Hatano et al.
5,468,678	A	11/1995	Nakamura et al.
5,725,674	A	3/1998	Moustakas et al.
5,777,350	A	7/1998	Nakamura et al.
5,923,950	A	7/1999	Ishibashi et al.
5,926,726	A	7/1999	Bour et al.
6,045,626	A	4/2000	Yano et al.
6,051,849	A	4/2000	Davis et al.

(Continued)

FOREIGN PATENT DOCUMENTS

EP	0 942 459	9/1999
----	-----------	--------

(Continued)

OTHER PUBLICATIONS

Patent Abstracts of Japan, vol. 2002, No. 04, Aug. 4, 2002 & JP 2001 342100 A (Toshiba Corp), Dec. 11, 2001.

(Continued)

(73) Assignees: **The Regents of the University of California**, Oakland, CA (US); **Japan Science and Technology Agency**, Kawaguchi, Saitama Prefecture (JP)

(*) Notice: Subject to any disclaimer, the term of this patent is extended or adjusted under 35 U.S.C. 154(b) by 0 days.

(21) Appl. No.: **11/697,457**

(22) Filed: **Apr. 6, 2007**

(65) **Prior Publication Data**

US 2007/0184637 A1 Aug. 9, 2007

Related U.S. Application Data

(63) Continuation of application No. 11/140,893, filed on May 31, 2005, now Pat. No. 7,208,393.

(60) Provisional application No. 60/576,685, filed on Jun. 3, 2004.

(51) **Int. Cl.**

H01L 29/04 (2006.01)

H01L 29/10 (2006.01)

H01L 31/036 (2006.01)

(52) **U.S. Cl.** **257/64; 257/65; 257/78; 257/E29.004; 257/E33.025**

Primary Examiner — Matthew S Smith

Assistant Examiner — Quovaunda Jefferson

(74) *Attorney, Agent, or Firm* — Gates & Cooper LLP

(57) **ABSTRACT**

A method of growing highly planar, fully transparent and specular m-plane gallium nitride (GaN) films. The method provides for a significant reduction in structural defect densities via a lateral overgrowth technique. High quality, uniform, thick m-plane GaN films are produced for use as substrates for polarization-free device growth.

7 Claims, 8 Drawing Sheets

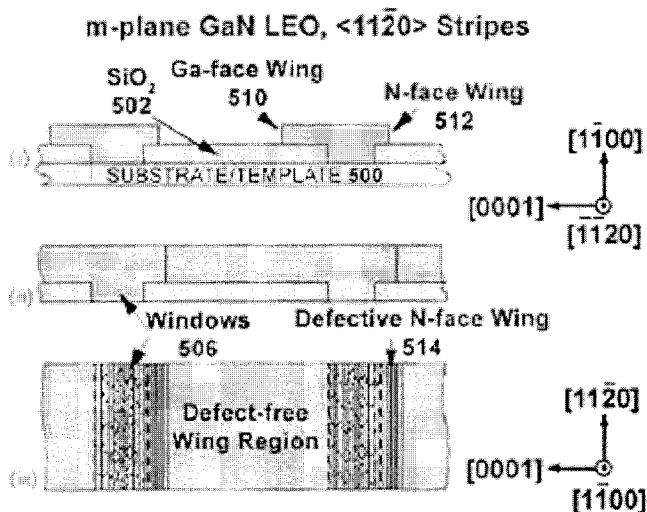

U.S. PATENT DOCUMENTS

6,064,078 A 5/2000 Northrup et al.
 6,069,021 A 5/2000 Terashima et al.
 6,072,197 A 6/2000 Horino et al.
 6,086,673 A 7/2000 Molnar
 6,153,010 A 11/2000 Kiyoku et al.
 6,156,581 A 12/2000 Vaudo et al.
 6,177,057 B1 1/2001 Purdy
 6,177,292 B1 1/2001 Hong et al.
 6,180,270 B1 1/2001 Cole et al.
 6,201,262 B1 3/2001 Edmond et al.
 6,218,280 B1 4/2001 Kryliouk et al.
 6,229,151 B1 5/2001 Takeuchi et al.
 6,259,122 B1 7/2001 Ota et al.
 6,265,089 B1 7/2001 Fatemi et al.
 6,268,621 B1 7/2001 Emmi et al.
 6,271,104 B1 8/2001 Razeghi et al.
 6,298,079 B1 10/2001 Tanaka et al.
 6,350,666 B2 2/2002 Kryliouk
 6,413,627 B1 7/2002 Motoki et al.
 6,440,823 B1 8/2002 Vaudo et al.
 6,441,391 B1 8/2002 Ohno et al.
 6,447,604 B1 9/2002 Flynn et al.
 6,468,882 B2* 10/2002 Motoki et al. 438/460
 6,569,704 B1 5/2003 Takeuchi et al.
 6,582,986 B2 6/2003 Kong et al.
 6,586,316 B2 7/2003 Tsuda et al.
 6,590,336 B1 7/2003 Kadota
 6,599,362 B2 7/2003 Ashby et al.
 6,602,763 B2 8/2003 Davis et al.
 6,623,560 B2 9/2003 Biwa et al.
 6,627,551 B2 9/2003 Liao
 6,635,901 B2 10/2003 Sawaki et al.
 6,645,295 B1* 11/2003 Koike et al. 117/89
 6,847,057 B1 1/2005 Gardner et al.
 6,849,472 B2 2/2005 Krames et al.
 6,882,051 B2 4/2005 Majumdar et al.
 6,900,070 B2 5/2005 Craven et al.
 6,951,695 B2 10/2005 Xu et al.
 6,969,426 B1 11/2005 Bliss et al.
 6,977,953 B2 12/2005 Hata et al.
 6,996,147 B2 2/2006 Majumdar et al.
 7,057,211 B2 6/2006 Dwilinski et al.
 7,091,514 B2 8/2006 Craven et al.
 7,132,730 B2 11/2006 Dwilinski et al.
 7,186,302 B2 3/2007 Chakraborty et al.
 7,208,096 B2 4/2007 Akkipeddi et al.
 2001/0011935 A1 8/2001 Lee et al.
 2001/0029086 A1 10/2001 Ogawa et al.
 2002/0005593 A1 1/2002 Bourret-Courchesne
 2002/0015866 A1 2/2002 Hooper et al.
 2002/0020341 A1 2/2002 Marchand et al.
 2002/0027933 A1 3/2002 Tanabe et al.
 2002/0047113 A1 4/2002 Ohno et al.
 2002/0069817 A1 6/2002 Mishra et al.
 2002/0074552 A1 6/2002 Weeks et al.
 2002/0098641 A1 7/2002 Tsuda et al.
 2002/0187356 A1 12/2002 Weeks et al.
 2003/0024472 A1* 2/2003 Maruska et al. 117/97
 2003/0114017 A1 6/2003 Wong et al.
 2003/0198837 A1 10/2003 Craven et al.
 2003/0213964 A1 11/2003 Flynn et al.
 2004/0094773 A1 5/2004 Kiyoku et al.
 2004/0108513 A1 6/2004 Narukawa et al.
 2004/0135222 A1 7/2004 Alfano et al.
 2004/0238810 A1* 12/2004 Dwilinski et al. 257/12
 2004/0245535 A1* 12/2004 D'Evelyn et al. 257/94
 2004/0251471 A1 12/2004 Dwilinski et al.
 2004/0261692 A1 12/2004 Dwilinski et al.
 2005/0205884 A1 9/2005 Kim et al.
 2005/0214992 A1 9/2005 Chakraborty et al.
 2005/0245095 A1 11/2005 Haskell et al.
 2006/0138431 A1 6/2006 Dwilinski et al.

JP 10-312971 11/1998
 JP 11-191657 7/1999
 JP 11-346002 12/1999
 JP 2001 257166 9/2001
 JP 2002 076329 3/2002
 JP 2002 076521 3/2002
 JP 2003 586403 4/2003
 WO WO 03/035945 * 5/2003
 WO 03/089694 A1 10/2003
 WO WO 2004/061909 7/2004
 WO WO 2004/061969 7/2004
 WO WO 2005/064643 7/2005

OTHER PUBLICATIONS

Gu et al., "The impact of initial growth and substrate nitridation on thick GaN growth on sapphire by hydride vapor phase epitaxy," Journal of Crystal Growth, vol. 231, No. 3, Oct. 2001, pp. 342-351.
 Wang, F. et al., "Crystal Tilting in the Epitaxial Laterally Overgrown GaN Films on Sapphire Substrate by Hydride Vapor Phase Epitaxy", Solid State and Integrated-Circuit Technology Proceedings, 6th International Conference, Oct. 2001, vol. 2, pp. 1998-1201.
 Maruska, H.P. et al., "Development of 50 mm Diameter Non-Polar Gallium Nitride Substrates for Device Applications", International Conference on Indium Phosphide and Related Materials, May 16, 2003, pp. 567-570.
 Craven, M.D., et al., "Structural characterization of nonpolar (1120) α -plane GaN thin films grown on (1102) r -plane sapphire", Applied Physics Letters, vol. 81, No. 3, Jul. 15, 2002, pp. 469-471, XP002250684.
 Dupuis, R.D., et al., "Selective-area and lateral epitaxial overgrowth of III-N materials by metalorganic chemical vapor deposition", Journal of Crystal Growth, vol. 195, No. 1-4, Dec. 15, 1998, pp. 340-345, XP004154285.
 Grzegory, I., et al., "Seeded growth of GaN at high N₂ pressure on (0 0 0 1) polar surfaces of GaN single crystalline substrates", Materials Science in Semiconductor Processing, vol. 4, No. 6. Dec. 2001, pp. 535-541, XP004345737.
 Liu, L. et al., "Substrates for gallium nitride epitaxy", Materials Science and Engineering R, Reports: A Review Journal, vol. 37, No. 3, Apr. 30, 2002, pp. 61-127, XP004349792.
 Marchand, H., et al., "Mechanisms of lateral epitaxial overgrowth of gallium nitride by metalorganic chemical vapor deposition", Journal of Crystal Growth, vol. 195, No. 1-4, Dec. 15, 1998, pp. 328-332, XP004154283.
 Mills, Alan, "Wide-bandgap emitters continue to improve", III-Vs Review, vol. 13, No. 3, May 2000, pp. 23-24, 26, 28-30, XP004200697.
 Sasaki, T., et al., "Substrate-orientation dependence of GaN single-crystal films grown by metalorganic vapor-phase epitaxy", Journal of Applied Physics, American Institute of Physics, vol. 61, No. 7, Apr. 1, 1987, pp. 2533-2540. XP000820119.
 Sun, Chien-Jen, et al., "Comparison of the physical properties of GaN thin films deposited on (0001) and (0112) sapphire substrates", Applied Physics Letters, vol. 63, No. 7, 1993, pp. 973-975, XP002251480.
 Amano, IL, et al., "Metalorganic vapor phasu epitaxial growth of a high quality GaN film using an AlN buffer layer" Appl. Phys. Lett. 48 (5), Feb. 3, 1986, pp. 353-355.
 Ambacher, O., et al., "Two-dimensional electron gases induced by spontaneous and piezoelectric polarization charges in N- and Ga-face AlGaIn/GaN heterostructures" J. Appl. Phys., 85 (6), Mar. 15, 1999, pp. 3222-3233.
 Bottcher, T., et al., "The role of high-temperature island coalescence in the development of stresses in GaN films" Appl. Phys. Lett. 78 (14), Apr. 2, 2001, pp. 1976-1978.
 Brandt, O., et al., "Determination of strain state and composition of highly mismatched group-III nitride heterostructures by x-ray diffraction" J. Phys. D. Appl. Phys. 35 (2002), pp. 577-585.
 Craven, M.D., et al., "Characterization of a-Plane GaN/(Al,Ga)N Multiple Quantum Wells Grown via Metalorganic Chemical Vapor Deposition" Jpn. J. Appl. Phys. vol. 42, (2003), pp. L235-L238.

FOREIGN PATENT DOCUMENTS

EP 1385196 A2 1/2004
 JP 03-003233 1/1991
 JP 05-183189 7/1993

- Craven, M.D., et al., "Threading dislocation reduction via laterally overgrown nonpolar (1120) a-plane GaN" *Appl. Phys. Lett.* 81 (7), Aug. 12, 2002, pp. 1201-1203.
- Dovidenko, K., et al., Characteristics of stacking faults in AlN thin films *J. Appl. Phys.* 82 (9), Nov. 1, 1997, pp. 4296-4299.
- Eastman, L. F., "The Toughest Transistor Yet" *IEEE Spectrum* 39 (5), May 2002, pp. 28-33.
- Eddy, C.R., Jr., "Growth of gallium nitride thin films by electron cyclotron resonance microwave plasma-assisted molecular beam epitaxy" *J. Appl. Phys.* 73 (1), Jan. 1, 1993, pp. 448-455.
- Etzkorn, E. V., et al., "Cracking of GaN films" *J. Appl. Phys.* 89 (2), Jan. 15, 2001, 1025-1034.
- Freitas, J. A., Jr., et al., "Optical characterization of lateral epitaxial overgrown GaN layers" *Appl. Phys. Lett.* 72 (23), Jun. 8, 1998, pp. 2990-2992.
- Grandjean, N., et al., "Built-in electric-field effects in wurtzite AlGaIn quantum wells" *J. Appl. Phys.* 86 (7), Oct. 1, 1999, pp. 3714-3720.
- Heying, B. et al., "Role of threading dislocation structure on the x-ray diffraction peak widths in epitaxial GaN films" *Appl. Phys. Lett.* 68 (5), Jan. 29, 1996, pp. 643-645.
- I. J. Seo, et al., "Reduction of oscillator strength due to piezoelectric fields in GaN/Al_xGa_{1-x}N quantum wells" *Phys. Rev. B.* 57 (16), Apr. 15, 1998-II, pp. R9435-R9438.
- Iwata, K., et al., "Gas Source Molecular Beam Epitaxy Growth of GaN on C-, A-, R-, and M-Plane Sapphire and Silica Glass Substrates" *Jpn. J. Appl. Phys.* vol. 36 (1997), pp. L 661-L664.
- Kapolack, D., et al., "Anisotropic epitaxial lateral growth in GaN selective area epitaxy" *Appl. Phys. Lett.* 71 (9), Sep. 1, 1997, pp. 1204-1206.
- Langer, B., et al., "Giant electric fields in unstrained GaN single quantum wells" *Appl. Phys. Lett.* 74 (25), Jun. 21, 1999, pp. 3827-3829.
- Lefebvre, P. et al., "High internal electric field in a graded-width InGaIn/GaN quantum well: Accurate determination by time-resolved photoluminescence spectroscopy" *Appl. Phys. Lett.* 78 (9), Feb. 26, 2001, pp. 1252-1254.
- Lefebvre, P., et al., "Time-resolved photoluminescence as a probe of internal electric fields in GaN-(GaAl)N quantum wells" *Phys. Rev. B.* 59 (23), Jun. 15, 1999-I, pp. 15363-15367.
- Lei, T., "Heteroepitaxy, polymorphism, and faulting in GaN thin films on silicon and sapphire substrates" *J. Appl. Phys.* 74 (7), Oct. 1, 1993, pp. 4430-4437.
- Leroux, M., "Barrier-width dependence of group-III nitrides quantum-well transition energies" *Phys. Rev. B.* 60 (3), Jul. 15, 1991-I, pp. 1496-1499.
- Leszczynski, M., et al., "Lattice parameters of gallium nitride" *Appl. Phys. Lett.* 69 (1), Jul. 1, 1996, pp. 73-75.
- Marchand, H., et al., "Microstructure of GaN laterally overgrown by metalorganic chemical vapor deposition" *Appl. Phys. Lett.* 73 (6), Aug. 10, 1998, pp. 747-749.
- Marchand, H., et al., "Atomic force microscopy observation of threading dislocation density reduction in lateral epitaxial overgrowth of gallium nitride by MOCVD" *MRS Internet J. Nitride Semicond. Res.* 3, 3 (1998), pp. 1-7.
- Metzger, Th., et al., "X-Ray Diffraction Study of Gallium Nitride Grown by MOCVD" *Physica status solidi (b)* 193, 1996, pp. 391-397.
- B. Monemar, et al., "Properties of Zn-doped VPE-grown GaN.I. Luminescence data in relation to doping conditions" *J. Appl. Phys.* 51 (1), Jan. 1980, pp. 625-639.
- Moustakas, T.D., et al., "Growth of GaN by ECR-assisted MBE" *Physics B* 185, 1993, pp. 36-49.
- Motoki, J., et al., "Preparation of Large Freestanding GaN Substrates by Hydride Vapor Phase Epitaxy Using GaAs as a Starting Substrate" *Jpn. J. Appl. Phys.* vol. 40 (2), (2001), pp. L140-L143.
- Nakamura, S., et al., "Violet InGaIn/GaN/AlGaIn-Based Laser Diodes Operable at 50° C. with a Fundamental Transverse Mode" *Jpn. J. Appl. Phys.* 38 (2), 1999, pp. L226-L229.
- Nam, O., et al., "Lateral epitaxy of low defect density GaN layers via organometallic vapor phase epitaxy" *Appl. Phys. Lett.* 71 (18), Nov. 3, 1997, pp. 2638-2640.
- Nataf, G., et al., "Lateral overgrowth of high quality GaN layers on GaN/Al₂O₃ patterned substrates by halide vapour-phase epitaxy" *J. of Crystal Growth* (192), Feb. 20, 1998, pp. 73-78.
- Ng, H. M., "Molecular-beam epitaxy of GaN/Al_xGa_{1-x}N multiple quantum wells on R-plane (1012) sapphire substrates" *Appl. Phys. Lett.* 80 (23), Jun. 10, 2002, pp. 4369-4371.
- Nishida, T., et al., "Ten Milliwatt Operation of an AlGaIn-Based Light Emitting Diode Grown on GaN Substrate" *Phys. Stat. Sol. (a)* 188 (1), 2001, pp. 113-116.
- Park, S., et al., "Spontaneous polarization effects in wurtzite GaN/AlGaIn quantum wells and comparison with experiment" *Appl. Phys. Lett.* 76 (15), Apr. 10, 2000, pp. 1981-1983.
- Park J., et al., "Selective-area and lateral epitaxial overgrowth of III-N materials by metal organic chemical vapor deposition" *Appl. Phys. Lett.* 73 (3), Jul. 20, 1998, pp. 333-335.
- Parilliaud, O., et al., "Localized Epitaxy of GaN by HVPE on patterned Substrates" *MRS Internet J. Nitride Semicond. Res.* 3 (40), Oct. 19, 1998, pp. 1-9.
- Paskova, T., et al., "Defect Reduction in HVPE Growth of GaN and Related Optical Spectra" *Phys. Stat. Sol. (a)* 183, (2001), pp. 197-203.
- Rosner, S.J., et al., "Cathodoluminescence mapping of epitaxial lateral overgrowth in gallium nitride" *Appl. Phys. Lett.* 74 (14), Apr. 5, 1999, pp. 2035-2037.
- Sakai, A., et al., "Self-organized propagation of dislocations in GaN films during epitaxial lateral overgrowth" *Appl. Phys. Lett.* 76 (4), Jan. 24, 2000, pp. 442-444.
- Sano, M., et al., "Epitaxial Growth of Undoped and Mg-Doped GaN" *Jpn. J. of Appl. Phys.* 15 (10), Oct. 1976, pp. 1943-1950.
- Shintani, A., et al., "Light Emitting Patterns of Gallium Nitride Electroluminescence" *J. Electrochem. Soc.* 123 (10), Oct. 1976, pp. 1575-1578.
- Smorchkova, I.P., et al., "Polarization-induced charge and electron mobility in AlGaIn/GaN heterostructures grown by plasma-assisted molecular-beam epitaxy" *J. Appl. Phys.* 86 (8), Oct. 15, 1999, pp. 4520-4526.
- Takeuchi, T., et al., "Determination of piezoelectric fields in strained GaInN quantum wells using the quantum-confined Stark effect" *Appl. Phys. Lett.* 73 (12), Sep. 21, 1998, pp. 1691-1693.
- Takeuchi, T., et al., "Quantum-Confined Stark Effect due to Piezoelectric Fields in GaInN Strained Quantum Wells" *Jpn. J. Appl. Phys.* vol. 36, Apr. 1, 1997, pp. L382-L385.
- Tan, I-H., et al., "A self consistent solution of Schrodinger-Poisson equations using a nonuniform mesh" *J. Appl. Phys.* 68 (8), Oct. 15, 1990, pp. 4071-4076.
- Tsuchiya, H., et al., "Growth condition dependence of GaN crystal structure on (0 0 1)GaAs by hydride vapor-phase epitaxy" *J. of Crystal Growth* (189/190), 1998, pp. 395-400.
- Waltereit, P., et al., "Nitride semiconductors free of electrostatic fields for efficient white light-emitting diodes" *Nature* vol. 406, Aug. 24, 2000, pp. 865-868.
- Wright, A.F., "Elastic properties of zinc-blende and wurtzite AlN, GaN, and InN" *J. Appl. Phys.* 82 (6), Sep. 15, 1997, pp. 2833-2839.
- Yablonovitch, E., et al., "Reduction of Lasing Threshold Current Density by the Lowering of Valence Band Effective Mass" *J. of Lightwave Tech.* vol. LT-4 (5), May 1986, pp. 504-506.
- Zheleva, T., et al., "Dislocation density reduction via lateral epitaxy in selectively grown GaN structures" *Appl. Phys. Lett.* 71 (17), Oct. 27, 1997, pp. 2472-2474.
- Zheleva, T., et al., "Pseudo-epitaxy—A new approach for lateral growth of gallium nitride structures" *MRS Internet J. Nitride Semicond. Res.* 4S1, G3.38 (1998).
- Yu., Z., et al., "Epitaxial lateral overgrowth of GaN on SiC and sapphire substrates" *MRS Internet J. Nitride Semicond. Res.* 4S1, G4.3 (1999).
- Kinoshita et al., "Emission Enhancement of GaN/AlGaIn Single-Quantum-Well Due to Screening of Piezoelectric Field", *MRS Internet J. Nitride Semicond. Res.* 5, W11.32 (2000).
- Leroux et al., "Quantum confined Stark effect due to built-in internal polarization fields in (Al,Ga)N/GaN quantum wells", *Phys. Rev. B* 58, R113371 (1998).

- Kuokatis et al., "Polarization effects in photoluminescence of C- and M-plane GaN/AlGaIn multiple quantum wells", *Appl. Phys. Lett.* 81, 4130 (2002).
- Bhattacharyya et al., "Comparative study of GaN/AlGaIn MQWs grown homoepitaxially on (1 1 0 0) and (0001) GaN", *Crystal Growth* 251, 487 (2003).
- Bernardini et al., "Spontaneous polarization and piezoelectric constants of III-V nitrides", *Phys. Rev. B* 56, R10024 (1997).
- Langer et al., "Giant electric fields in unstrained GaN single quantum wells", *Appl. Phys. Lett.* 74, 3827 (1999).
- Traetta et al., "Effects of the spontaneous polarization and piezoelectric fields on the luminescence spectra of GaN/Al_{0.15}Ga_{0.85}N quantum wells", *Physics E* 7, 929-933 (2000).
- Keller et al., "Metalorganic Chemical Vapor Deposition Growth of High Optical Quality and High Mobility GaN", *J. Electronic Materials* vol. 24, pp. 1707-1709 (1995).
- Chakraborty et al., "Nonpolar InGaIn/GaN emitters on reduced-defect lateral epitaxially overgrown a-plane GaN with drive-current-independent electroluminescence emission peak", *Applied Physics Letters* vol. 85 No. 22, (Nov. 29, 2004).
- Chitnis et al., "Visible light-emitting diodes using a-plane GaN-InGaIn multiple quantum wells over r-plane sapphire". *Applied Physics Letters* vol. 84 No. 18 (May 3, 2004).
- Gardner et al., "Polarization anisotropy in the electroluminescence of m-plane InGaIn-GaN multiple-quantum-well light-emitting diodes", *Applied Physics Letters* 86, 111101 (2005).
- Vanfleet et al., "Defects in m-face GaN films grown in halide vapor phase epitaxy on LiAlO₂", *Applied Physics Letters*, vol. 83 No. 6 (Aug. 11, 2003).
- Haskell et al., "Defect reduction in (1 1 2 0) a-plane gallium nitride via lateral epitaxial overgrowth by hydride vapor-phase epitaxy", *Applied Physics Letters*, vol. 83 No. 4 (Jul. 28, 2003).
- Yue Jun Sun et al., "In surface segregation in M-plane (In,Ga)N/GaN multiple quantum well structures", *Applied Physics Letters*, vol. 83 No. 25 (Dec. 22, 2003).
- Bigenwald et al., "Confined Excitons in GaN-AlGaIn Quantum Wells", *Phys. Stat. Sol. (b)* 216, 371 (1999).
- Im, J.S. et al., "Reduction of oscillator strength due to piezoelectric fields in GaN/Al_xGa_{1-x}N quantum wells", *Phys. Rev. B*, vol. 57 No. 16 Apr. 15, 1998.
- Nam, Ok-Hyun et al., "Lateral epitaxy of low defect density GaN layers via organometallic vapor phase epitaxy", *Appl Phys. Lett.* 71 (18) (Nov. 3, 1971).
- Zheleva et al., "Dislocation density reduction via lateral epitaxy in selectively grown GaN structures", *Appl. Phys. Lett.* 71 (17) (Oct. 27, 1997).
- Yue Jun Sun et al., "Nonpolar In_xGa_{1-x}N/GaN(1100) multiple quantum wells grown on γ -LiAlO₂(100) by plasma-assisted molecular-beam epitaxy", *Physical Review B* 67 (2003).
- Takeuchi et al., "Theoretical Study of Orientation Dependence of Piezoelectric Effects in Wurtzite Strained GaInN/GaN 1-Heterostructures and Quantum Wells", *Jpn. J. Appl. Phys.* vol. 39, pp. 413-416, Part No. 1, No. 2A (Feb. 2000).
- Grandjean et al., "Self-limitation of AlGaIn/GaN quantum well energy by built-in polarization field", *Applied Physics Letters*, vol. 74, No. 16 (Apr. 19, 1999).
- Amano et al., "Stress and Defect Control in GaN Using Low Temperature Interlayers", *Jpn. J. Appl. Phys.*, vol. 37 (1998).
- Mukai et al., "Ultraviolet InGaIn and GaN Singly-Quantum-Well-Structure Light-Emitting Diodes Grown on Epitaxially Laterally Overgrown GaN Substrates", *Jpn. J. Appl. Phys.*, vol. 38, pp. 5735-5739 (1999).
- Miller et al., "Electric field dependence of optical absorption near the band gap of quantum-well structures", *The American Physical Society, Physical Review B*, vol. 32, No. 2 (Jul. 15, 1985).
- Pearson et al., "GaN: Processing, defects, and devices", *Applied Physics Reviews, Journal of Applied Physics*, vol. 86, No. 1 (Jul. 1, 1999).
- S. Nakamura and G. Fasol, *The Blue Laser Diode*, (Springer, Heidelberg, 1997), pp. 160-178.
- Amano, H. et al., "Stress and Defect Control in GaN Using Low Temperature Interlayers", *Jpn. J. Appl. Phys.* vol. 37 (1998), pp. L 1540-L 1542.
- T. Gehrke et al., "Pendeo-Epitaxy of Gallium Nitride and Aluminum Nitride Films and Heterostructure on Silicon Carbide Substrate," *MRS Internet J. Semicond. Res.* 451,G3.2, 1999, 6 pp.
- M. Iwaya et al., "Reduction of Etch Pit Density in Organometallic Vapor Phase Epitaxy-Grown GaN on Sapphire by Insertion of a Low-Temperature-Deposited Buffer Layer Between High-Temperature-Grown GaN," *Jpn. J. Appl. Phys.*, 1998, 37: L316-L318.
- S. Keller et al., "Spiral Growth of InGaIn Nanoscale Islands on GaN," *Jpn. J. Appl. Phys.*, 1998, 37: L431-L434.
- P. Kozodoy et al., "Electrical Characterization of GaN *p-n* Junctions With and Without Threading Dislocations," *Appl. Phys. Lett.*, 1998, 73(7): 975-977.
- S. Nakamura et al., "InGaIn/GaN/AlGaIn-Based Laser Diodes with Modulation-Doped Strained-Layer Superlattices Grown on an Epitaxially Laterally Overgrown GaN Substrate," *Appl. Phys. Lett.*, 1998, 72(2): 211-213.
- G. Parish et al., "High-Performance (Al,Ga) N-Based Solar-Blind Ultraviolet *p-i-n* Detectors on Laterally Epitaxially Overgrown GaN," *Appl. Phys. Lett.*, 1999, 75(2): 247-249.
- V. Srikant et al., "Mosaic Structure in Epitaxial Thin Films Having Large Lattice Mismatch," *J. Appl. Phys.*, 1997, 82(9): 4286-4295.
- S. Tanaka et al., "Anti-Surfactant in III-Nitride-Epitaxy—Quantum Dot Formation and Dislocation Termination," *Jpn. J. Appl. Phys.*, 2000, 39: L831-L834.
- S. Tanaka et al., "Self-Assembling GaN Quantum Dots on Al_xGa_{1-x}N Surfaces Using a Surfactant," *Appl. Phys. Lett.*, 1996, 69(26): 4096-4098.
- A. Usui et al., "Thick GaN Epitaxial Growth with Low Dislocation Density by Hydride Vapor Phase Epitaxy," *Jpn. J. Appl. Phys.*, 1997, 36: L899-L902.
- Aujol et al., "Hydrogen and Nitrogen Ambient Effects on Epitaxial Growth of GaN by Hydride Vapor Phase Epitaxy," *Journal of Crystal Growth*, 2001, 230, pp. 372-376.
- Waltereit et al., "M-Plane GaN (1100) Grown on γ -LiAlO₂ (100): Nitride Semiconductors Free of Internal Electrostatic Fields," *Journal of Crystal Growth*, 2001, 227-228, pp. 437-441.
- Chakraborty et al., "Demonstration of nonpolar *m*-plane InGaIn/GaN light-emitting diodes on free-standing *m*-plane GaN substrates," *Japan J. Appl. Phys.* 2005, vol. 44(5), pp. L173-L175.
- Chen et al., "A new selective area lateral epitaxy approach for depositing *a*-plane GaN over *r*-plane sapphire," *Japan J. Appl. Phys.* 2003, vol. 42 (part. 2, No. 7B), pp. L818-L820.
- Funato et al., "Blue, green and amber InGaIn/GaN light-emitting diodes on semipolar {11-22} GaN bulk substrates," *Jap. Journal Appl. Phys.*, vol. 45, No. 26 (2006), pp. L659-L662 (abstract only).
- Ghandhi, "VLSI fabrication principles: silicon and gallium arsenide," 2nd Edition, Wiley-Interscience, 1994, pp. 639-642.
- "Kyma Technologies announces improved and expanded native gallium nitride product line," Mar. 20, 2006, Company News Releases, retrieved from <http://www.compoundsemi.com/documents/articles/cldoc/6524.html>.
- McMahan, "Dr. Shuji Nakamura and UCSB research team report first nonpolar and semi-polar GaN LEDs," *Compoundsemi Online*, Mar. 24, 2006, one page.
- Moe et al., "Milliwatt power deep ultraviolet light emitting diodes grown on silicon carbide," *Japan J. Appl. Phys.* 2005, vol. 44 (17), pp. L502-L504.
- Neubert, "Growth characteristics of GaInN quantum wells on semipolar GaN facets," *Annual Report 2005, Optoelectronics Department, University of Ulm* 2006, pp. 1-6.
- Nichizuka, "Efficient radiative recombination from <1122>-oriented In_xGa_{1-x}N multiple quantum wells fabricated by the regrowth technique," *Applied Physics Letters*, Oct. 2004, vol. 85, No. 15, pp. 3122-3124, abstract.
- Ohba et al., "A study on strong memory effects for Mg doping in GaN metalorganic chemical vapor deposition," *J. Cryst. Growth*, vol. 145, 1994, pp. 214-218.
- Okamoto et al., "Dislocation-free *m*-plane InGaIn/GaN light-emitting diodes on *m*-plane GaN single crystals," *Japanese Journal of Applied Physics*, vol. 45, 2006, pp. L1197-L1199.
- Sharma et al., "Demonstration of a semipolar (1013) InGaIn/GaN green light emitting diode," *Applied Physics Letters* 87, 231110 (2005), pp. 1-3.

US 7,956,360 B2

Page 5

EP Application 03726251.6, Office Action dated Sep. 15, 2010.
EP Application No. 03723982.9, Office Action dated Sep. 15, 2010.
EP Application No. 03719699.5—Office Action dated Sep. 16, 2010.
International Search Report, International application No. PCT/
US03/21916, International filing date Jul. 15, 2003.
International Search Report, International application No. PCT/
US03/39355, mailing date Sep. 29, 2004.
International Search Report, International application No. PCT/
US03/21918, International filing date Apr. 15, 2004.
Office Action mailed Jul. 2, 2007, U.S. Appl. No. 10/537,385, filed
Jun. 3, 2005.
Office Action mailed Apr. 7, 2006, U.S. Appl. No. 10/537,644, filed
Jun. 6, 2005.

Office Action mailed Aug. 14, 2007, U.S. Appl. No. 10/582,390, filed
Jun. 9, 2006.
Office Action mailed May 29, 2008, U.S. Appl. No. 10/582,390, filed
Jun. 9, 2006.
Office Action mailed Nov. 12, 2008, U.S. Appl. No. 10/582,390, filed
Jun. 9, 2006.
Office Action mailed Jan. 18, 2006, U.S. Appl. No. 11/140,893, filed
May 31, 2005.
Office Action mailed Jul. 14, 2006, U.S. Appl. No. 11/140,893, filed
May 31, 2005.
Office Action mailed Jan. 3, 2007, U.S. Appl. No. 11/444,083, filed
May 31, 2006.

* cited by examiner

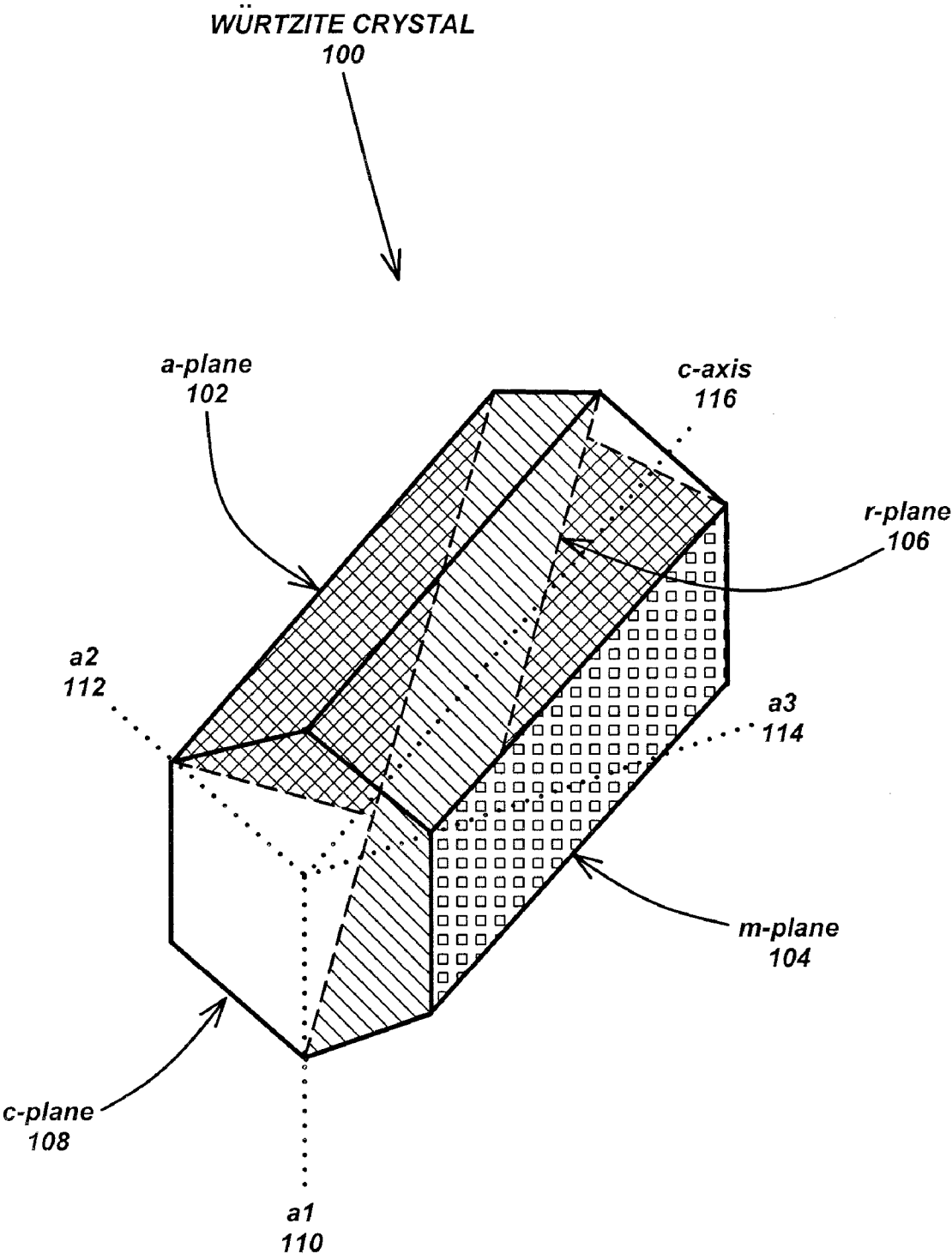

FIG. 1

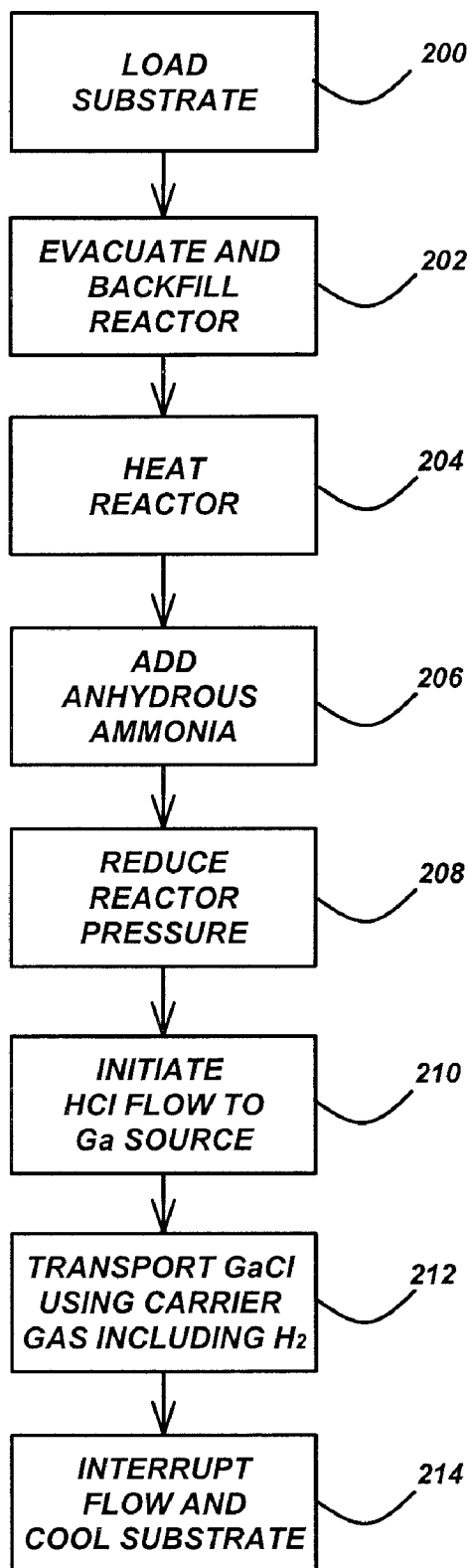

FIG. 2

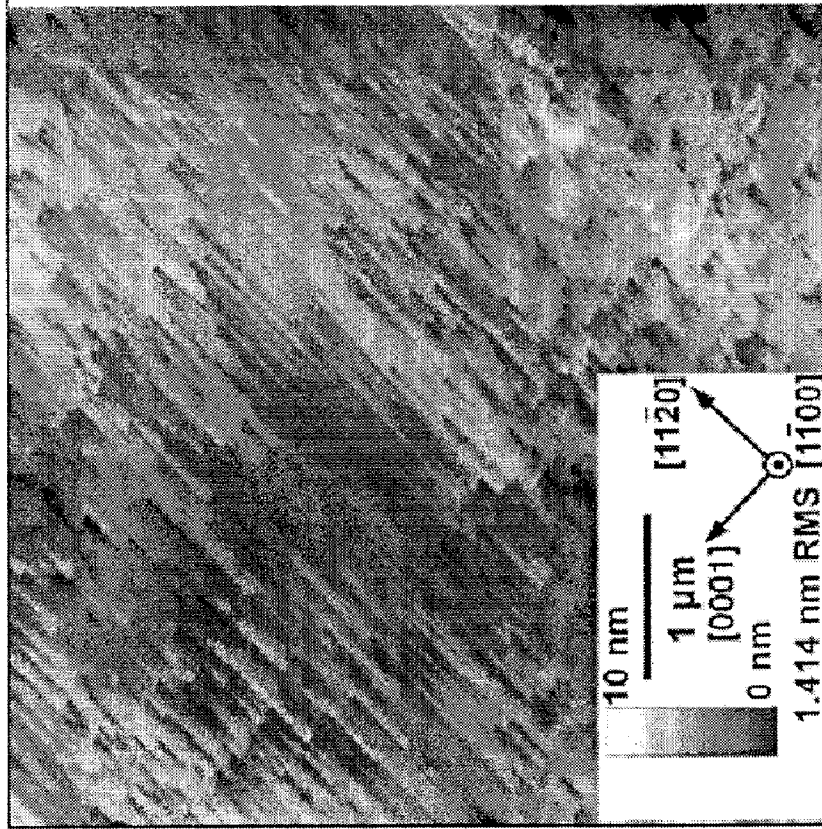

FIG. 3(b)

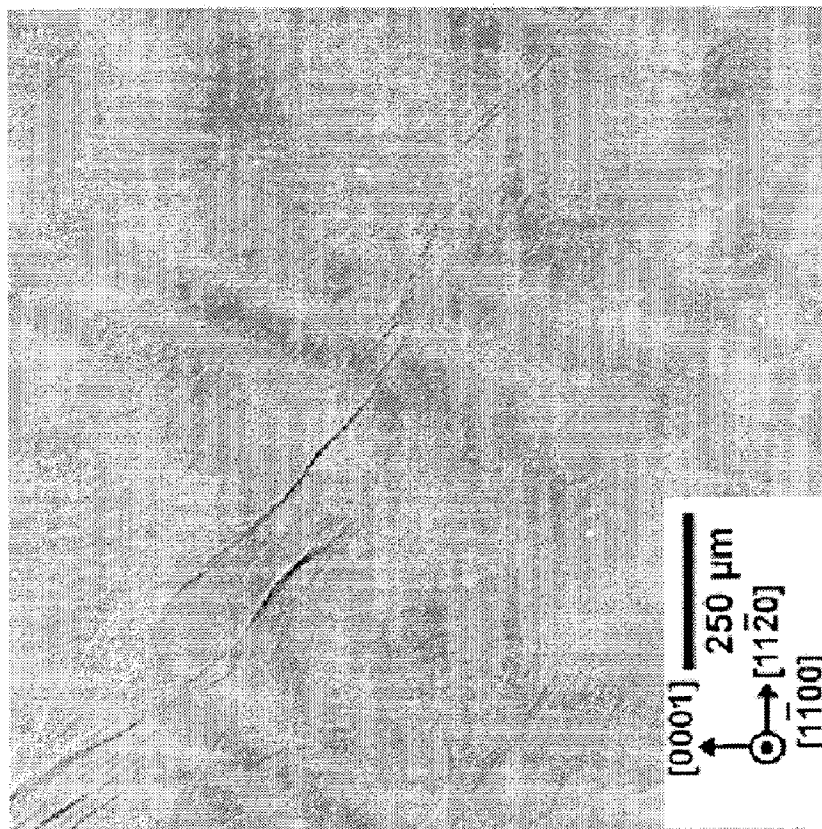

FIG. 3(a)

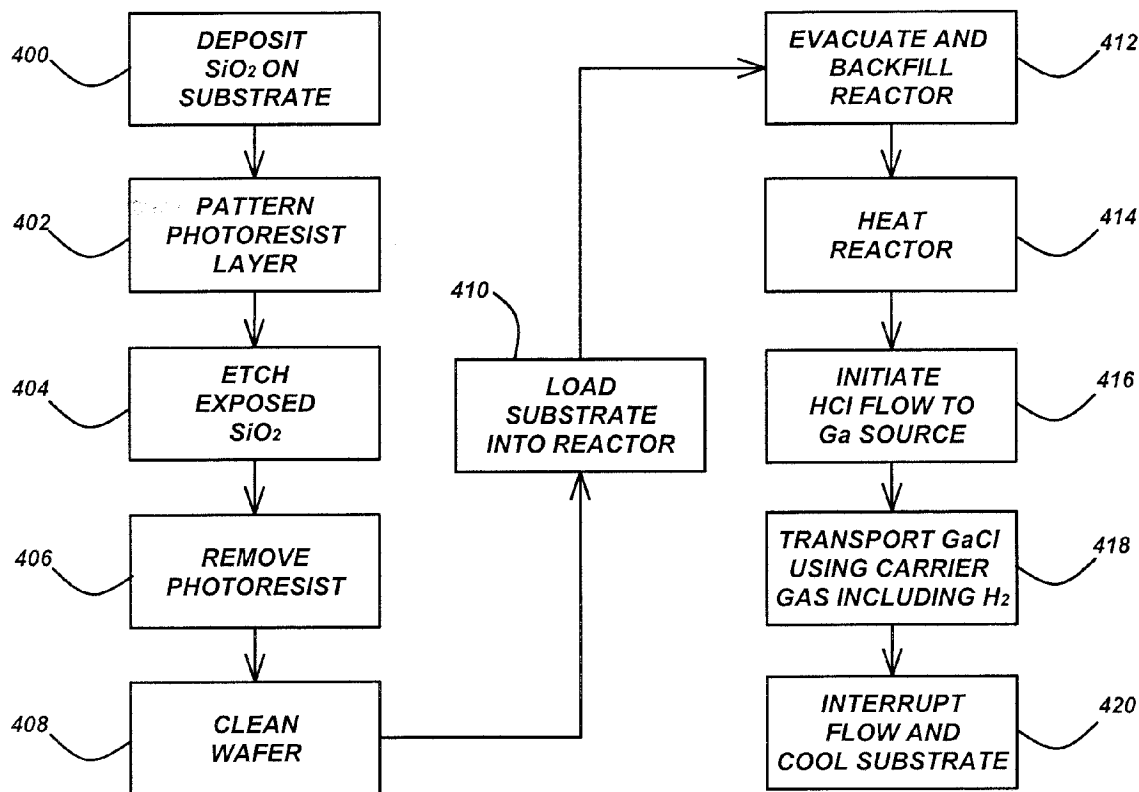

FIG. 4

m-plane GaN LEO, $\langle 0001 \rangle$ Stripes

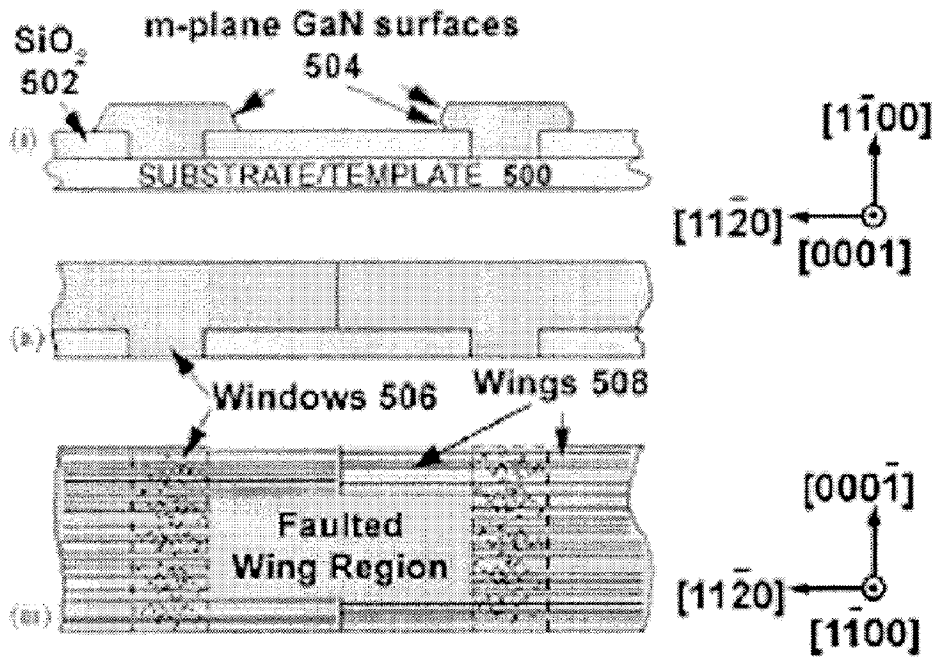

FIG 5(a)

m-plane GaN LEO, $\langle 11\bar{2}0 \rangle$ Stripes

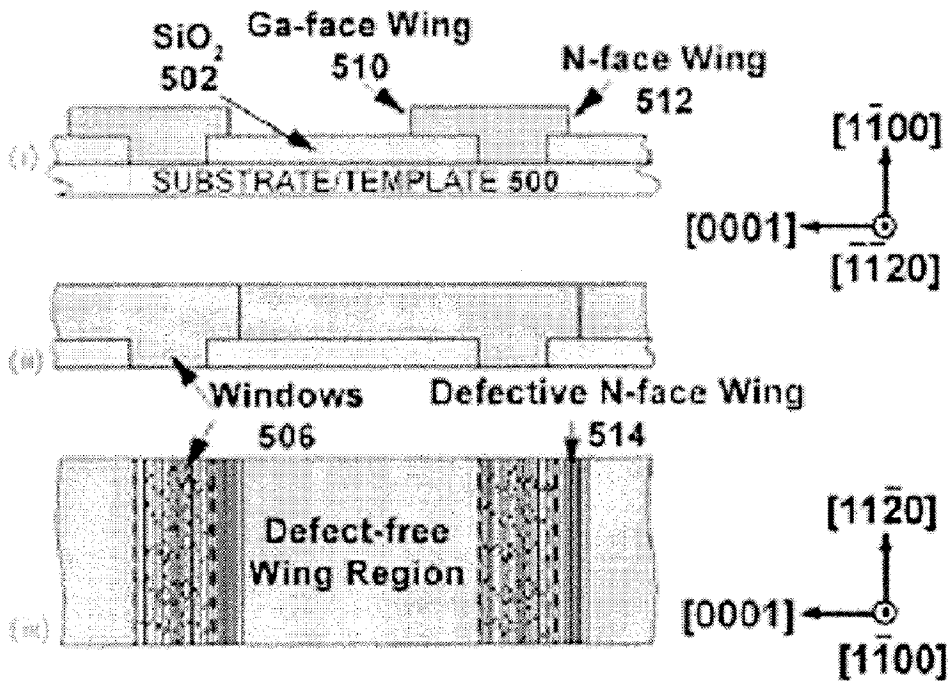

FIG 5(b)

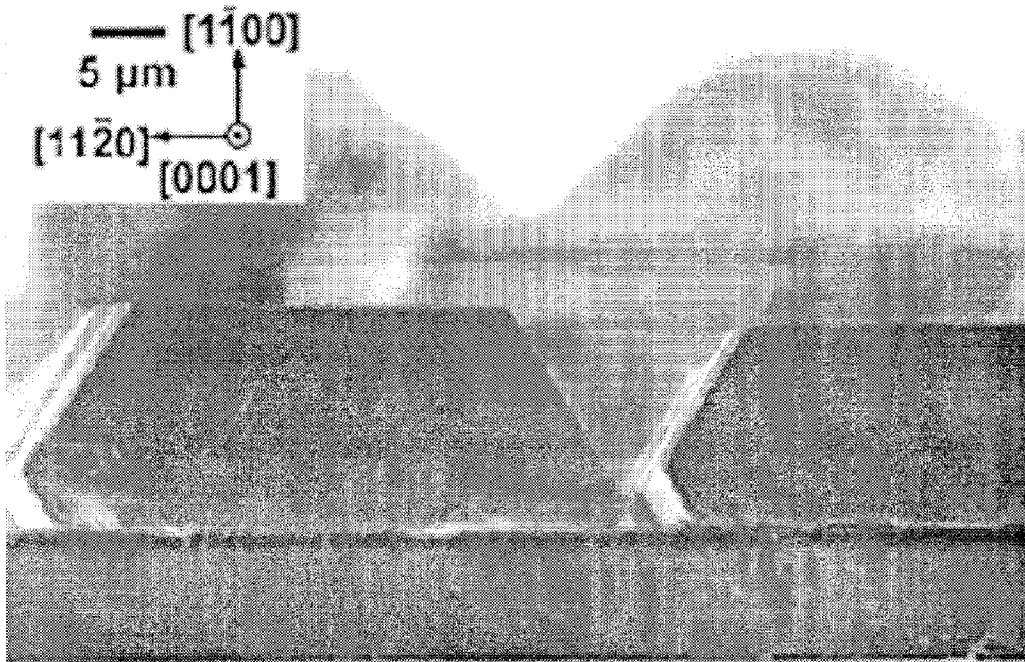

FIG. 6(a)

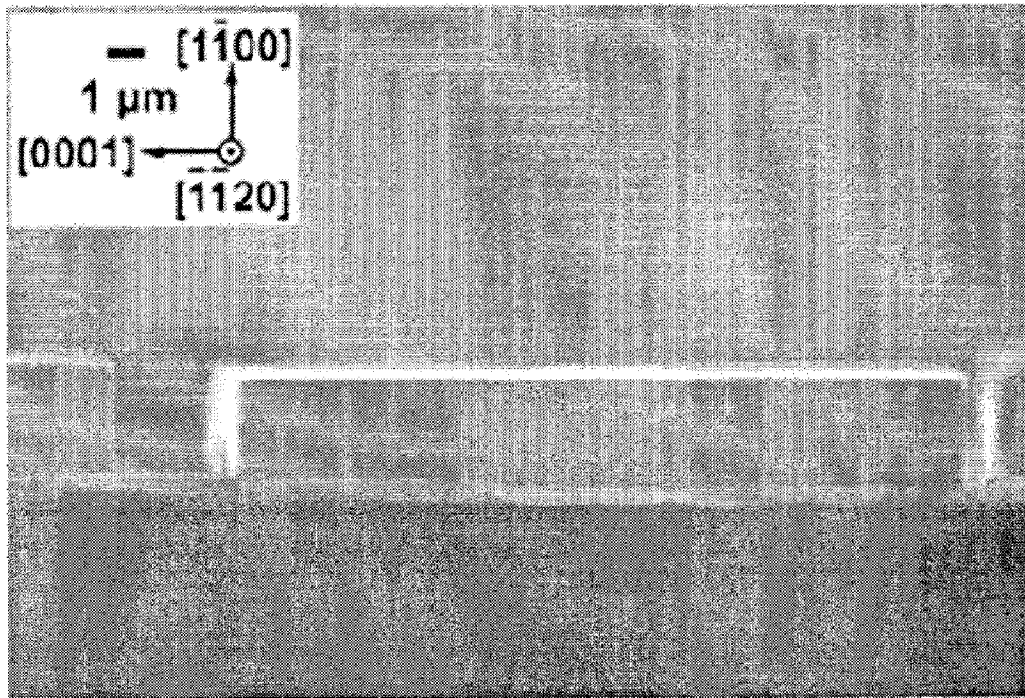

FIG. 6(b)

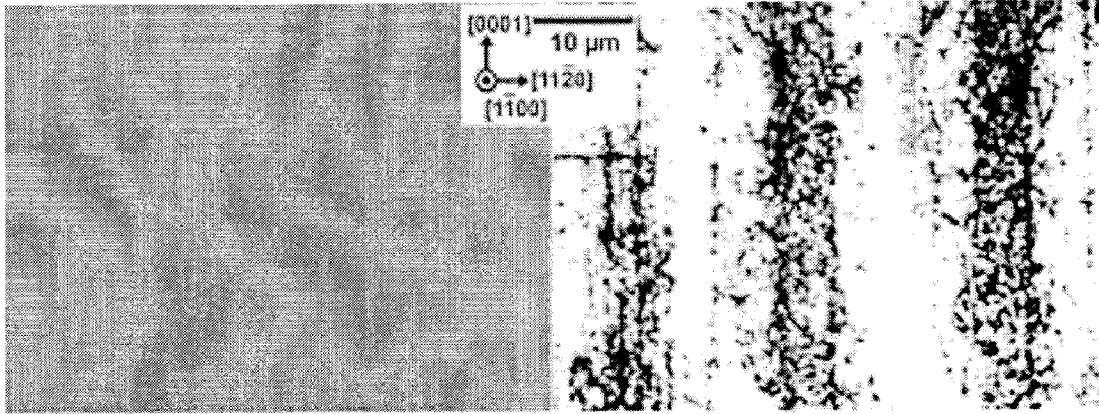

FIG. 7(a)

FIG. 7(b)

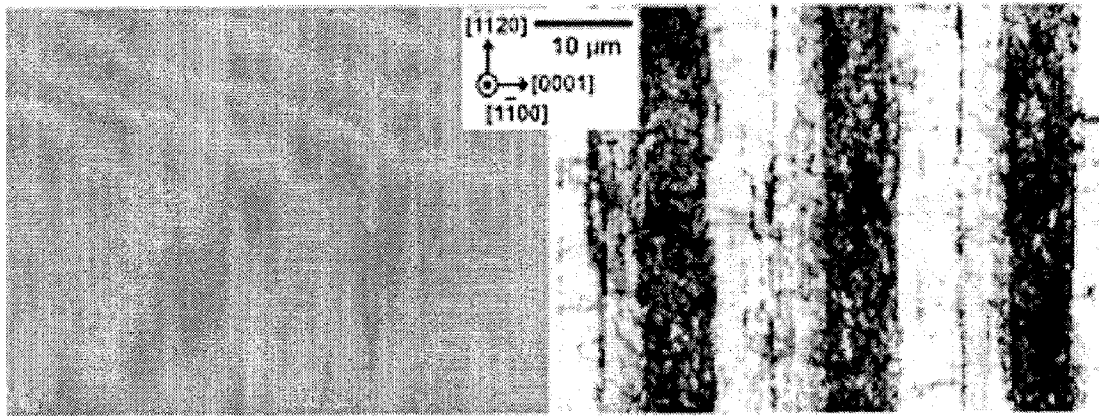

FIG. 7(c)

FIG. 7(d)

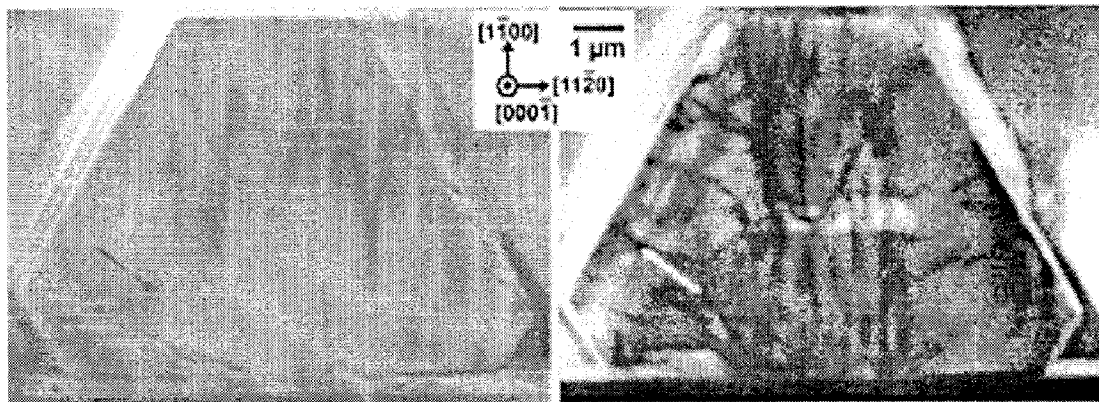

FIG. 7(e)

FIG. 7(f)

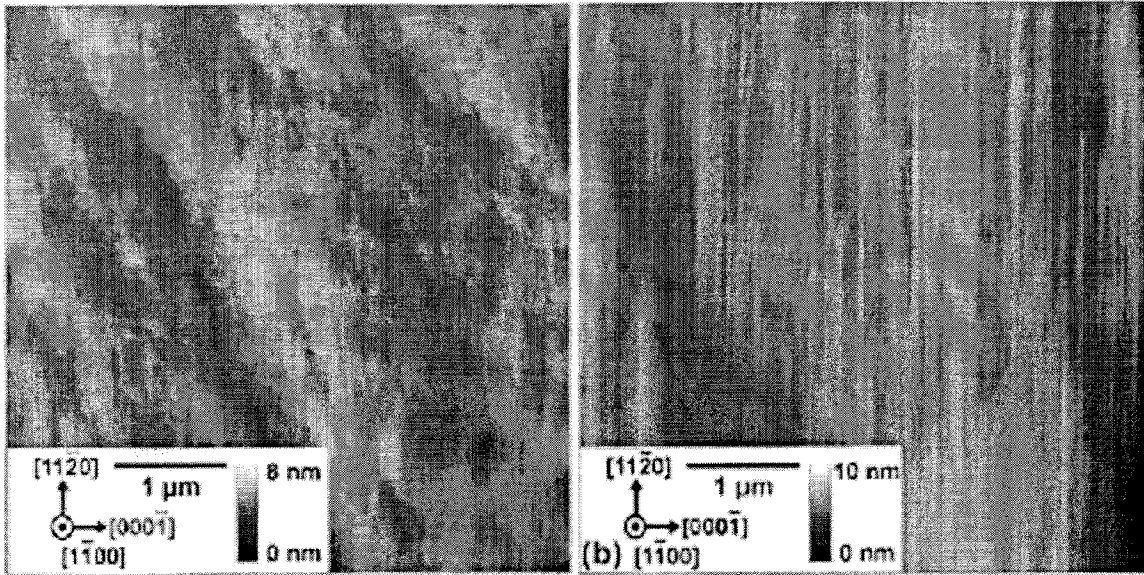

FIG. 8(a)

FIG. 8(b)

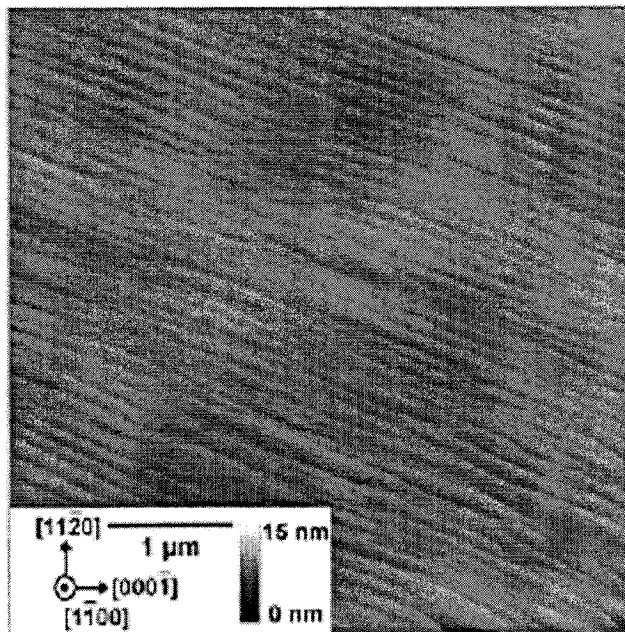

FIG. 8(c)

**GROWTH OF PLANAR REDUCED
DISLOCATION DENSITY M-PLANE
GALLIUM NITRIDE BY HYDRIDE VAPOR
PHASE EPITAXY**

CROSS-REFERENCE TO RELATED
APPLICATIONS

This application is a continuation under 35 U.S.C. Section 120 of commonly-assigned U.S. Utility patent application Ser. No. 11/140,893, filed on May 31, 2005, by Benjamin A. Haskell, Melvin B. McLaurin, Steven P. DenBaars, James S. Speck, and Shuji Nakamura, entitled "GROWTH OF PLANAR REDUCED DISLOCATION DENSITY M-PLANE GALLIUM NITRIDE BY HYDRIDE VAPOR PHASE EPITAXY," now U.S. Pat. No. 7,208,393 issued Apr. 24, 2007,

which application claims the benefit under 35 U.S.C. Section 119(e) of U.S. Provisional Patent Application Ser. No. 60/576,685, filed on Jun. 3, 2004, by Benjamin A. Haskell, Melvin B. McLaurin, Steven P. DenBaars, James S. Speck, and Shuji Nakamura, entitled "GROWTH OF PLANAR REDUCED DISLOCATION DENSITY M-PLANE GALLIUM NITRIDE BY HYDRIDE VAPOR PHASE EPITAXY," and

which application is a continuation-in-part and claims the benefit under 35 U.S.C. Sections 119, 120 and/or 365 of the following co-pending and commonly-assigned patent applications:

International Patent Application No. PCT/US03/21918, filed Jul. 15, 2003, by Benjamin A. Haskell, Michael D. Craven, Paul T. Fini, Steven P. DenBaars, James S. Speck, and Shuji Nakamura, entitled "GROWTH OF REDUCED DISLOCATION DENSITY NON-POLAR GALLIUM NITRIDE BY HYDRIDE VAPOR PHASE EPITAXY," which application claims priority to U.S. Provisional Patent Application Ser. No. 60/433,843, filed Dec. 16, 2002, by Benjamin A. Haskell, Michael D. Craven, Paul T. Fini, Steven P. DenBaars, James S. Speck, and Shuji Nakamura, entitled "GROWTH OF REDUCED DISLOCATION DENSITY NON-POLAR GALLIUM NITRIDE BY HYDRIDE VAPOR PHASE EPITAXY,";

International Patent Application No. PCT/US03/21916, filed Jul. 15, 2003, by Benjamin A. Haskell, Paul T. Fini, Shigemasa Matsuda, Michael D. Craven, Steven P. DenBaars, James S. Speck, and Shuji Nakamura, entitled "GROWTH OF PLANAR, NON-POLAR A-PLANE GALLIUM NITRIDE BY HYDRIDE VAPOR PHASE EPITAXY," which application claims priority to U.S. Provisional Patent Application Ser. No. 60/433,844, filed Dec. 16, 2002, by Benjamin A. Haskell, Paul T. Fini, Shigemasa Matsuda, Michael D. Craven, Steven P. DenBaars, James S. Speck, and Shuji Nakamura, entitled "TECHNIQUE FOR THE GROWTH OF PLANAR, NON-POLAR A-PLANE GALLIUM NITRIDE BY HYDRIDE VAPOR PHASE EPITAXY,";

U.S. Utility patent application Ser. No. 10/413,691, filed Apr. 15, 2003, by Michael D. Craven and James S. Speck, entitled "NON-POLAR A-PLANE GALLIUM NITRIDE THIN FILMS GROWN BY METALORGANIC CHEMICAL VAPOR DEPOSITION," which application claims priority to U.S. Provisional Patent Application Ser. No. 60/372,909, filed Apr. 15, 2002, by Michael D. Craven, Stacia Keller, Steven P. DenBaars, Tal Margalith, James S. Speck, Shuji Nakamura, and Umesh K. Mishra, entitled "NON-POLAR GALLIUM NITRIDE BASED THIN FILMS AND HETEROSTRUCTURE MATERIALS,";

U.S. Utility patent application Ser. No. 10/413,690, filed Apr. 15, 2003, by Michael D. Craven, Stacia Keller, Steven P. DenBaars, Tal Margalith, James S. Speck, Shuji Nakamura, and Umesh K. Mishra, entitled "NON-POLAR (Al,B,In,Ga)_N QUANTUM WELL AND HETEROSTRUCTURE MATERIALS AND DEVICES, now U.S. Pat. No. 7,091,514 issued Aug. 15, 2006, which application claims priority to U.S. Provisional Patent Application Ser. No. 60/372,909, filed Apr. 15, 2002, by Michael D. Craven, Stacia Keller, Steven P. DenBaars, Tal Margalith, James S. Speck, Shuji Nakamura, and Umesh K. Mishra, entitled "NON-POLAR GALLIUM NITRIDE BASED THIN FILMS AND HETEROSTRUCTURE MATERIALS,";

U.S. Utility patent application Ser. No. 10/413,913, filed Apr. 15, 2003, by Michael D. Craven, Stacia Keller, Steven P. DenBaars, Tal Margalith, James S. Speck, Shuji Nakamura, and Umesh K. Mishra, entitled "DISLOCATION REDUCTION IN NON-POLAR GALLIUM NITRIDE THIN FILMS," now U.S. Pat. No. 6,900,070 issued May 31, 2005, which application claims priority to U.S. Provisional Patent Application Ser. No. 60/372,909, filed Apr. 15, 2002, by Michael D. Craven, Stacia Keller, Steven P. DenBaars, Tal Margalith, James S. Speck, Shuji Nakamura, and Umesh K. Mishra, entitled "NON-POLAR GALLIUM NITRIDE BASED THIN FILMS AND HETEROSTRUCTURE MATERIALS,";

International Patent Application No. PCT/US03/39355, filed Dec. 11, 2003, by Michael D. Craven and Steven P. DenBaars, entitled "NONPOLAR (Al, B, In, Ga)_N QUANTUM WELLS," which application is a continuation-in-part of the above Patent Application Nos. PCT/US03/21918, PCT/US03/21916, Ser. No. 10/413,691, Ser. No. 10/413,690, Ser. No. 10/413,913; and

U.S. Utility patent application Ser. No. 11/123,805, filed May 6, 2005, by Arpan Chakraborty, Benjamin A. Haskell, Stacia Keller, James S. Speck, Steven P. DenBaars, Shuji Nakamura, and Umesh K. Mishra, entitled "FABRICATION OF NONPOLAR INDIUM GALLIUM NITRIDE THIN FILMS, HETEROSTRUCTURES AND DEVICES BY METALORGANIC CHEMICAL VAPOR DEPOSITION," now U.S. Pat. No. 7,186,302 issued Mar. 6, 2007, which application claims priority to U.S. Provisional Patent Application Ser. No. 60/569,749, filed May 10, 2004, by Arpan Chakraborty, Benjamin A. Haskell, Stacia Keller, James S. Speck, Steven P. DenBaars, Shuji Nakamura, and Umesh K. Mishra, entitled "FABRICATION OF NONPOLAR INGAN THIN FILMS, HETEROSTRUCTURES AND DEVICES BY METALORGANIC CHEMICAL VAPOR DEPOSITION,";

all of which applications are incorporated by reference herein.

BACKGROUND OF THE INVENTION

1. Field of the Invention

The present invention is related to compound semiconductor growth and device fabrication. More particularly the invention relates to the growth and fabrication of planar, m-plane gallium nitride (GaN) films by performing a direct growth of the planar m-plane GaN films by hydride vapor phase epitaxy, optionally followed by a lateral epitaxial overgrowth of the GaN films to achieve reduced dislocation density.

2. Description of the Related Art

(Note: The specification of this application references various publications. The full citation of each of these publica-

tions can be found below in the section entitled "References." Each of these publications is incorporated by reference herein.)

The usefulness of gallium nitride (GaN) and its ternary and quaternary compounds incorporating aluminum and indium (AlGaIn, InGaIn, AlInGaIn) has been well established for fabrication of visible and ultraviolet optoelectronic devices and high-power electronic devices. These devices are typically grown epitaxially by growth techniques including molecular beam epitaxy (MBE), metalorganic chemical vapor deposition (MOCVD), or hydride vapor phase epitaxy (HVPE).

GaN and its alloys are most stable in the hexagonal wurtzite crystal structure, in which the structure is described by two (or three) equivalent basal plane axes that are rotated 120° with respect to each other (the a-axes), all of which are perpendicular to a unique c-axis. FIG. 1 is a schematic of a generic hexagonal wurtzite crystal structure 100 and planes of interest 102, 104, 106, 108 with these axes 110, 112, 114, 116 identified therein, wherein the fill patterns are intended to illustrate the planes of interest 102, 104 and 106, but do not represent the materials of the structure 100. Group III and nitrogen atoms occupy alternating c-planes along the crystal's c-axis. The symmetry elements included in the wurtzite structure dictate that III-nitrides possess a bulk spontaneous polarization along this c-axis. Furthermore, as the wurtzite crystal structure is non-centrosymmetric, wurtzite nitrides can and do additionally exhibit piezoelectric polarization, also along the crystal's c-axis. Current nitride technology for electronic and optoelectronic devices employs nitride films grown along the polar c-direction. However, conventional c-plane quantum well structures in III-nitride based optoelectronic and electronic devices suffer from the undesirable quantum-confined Stark effect (QCSE), due to the existence of strong piezoelectric and spontaneous polarizations. The strong built-in electric fields along the c-direction cause spatial separation of electrons and holes that in turn give rise to restricted carrier recombination efficiency, reduced oscillator strength, and red-shifted emission.

One possible approach to eliminating the spontaneous and piezoelectric polarization effects in GaN optoelectronic devices is to grow the devices on non-polar planes of the crystal. Such planes contain equal numbers of Ga and N atoms and are charge-neutral. Furthermore, subsequent non-polar layers are equivalent to one another so the bulk crystal will not be polarized along the growth direction. Two such families of symmetry-equivalent non-polar planes in GaN are the {11 $\bar{2}$ 0} family, known collectively as α -planes, and the {100} family, known collectively as m-planes.

Indeed, (Al,Ga,In,B)N quantum-well structures employing nonpolar growth directions, e.g. the $\langle 11\bar{2}0 \rangle$ a-direction or $\langle 1100 \rangle$ m-direction, have been shown to provide an effective means of eliminating polarization-induced electric field effects in wurtzite nitride structures since the polar axis lies within the growth plane of the film, and thus parallel to heterointerfaces of quantum wells. In the last few years, growth of nonpolar (Al,Ga,In)N has attracted great interest for its potential use in the fabrication of nonpolar electronic and optoelectronic devices. Recently, nonpolar m-plane AlGaIn/GaN quantum wells grown on lithium aluminate substrates via plasma-assisted MBE and nonpolar α -plane AlGaIn/GaN multi-quantum wells (MQWs) grown by both MBE and MOCVD on r-plane sapphire substrates showed the absence of polarization fields along the growth direction. More recently, Sun et al. [Sun et al., Appl. Phys. Lett. 83 (25) 5178 (2003)], and Gardner et al. [Gardner et al., Appl. Phys. Lett. 86, 111101 (2005)], heteroepitaxially grew m-plane

InGaIn/GaN quantum well structures by MBE and MOCVD, respectively. Chitnis et al. [Chitnis et al., Appl. Phys. Lett. 84 (18) 3663 (2004)], grew α -plane InGaIn/GaN structures by MOCVD. Most significantly, researchers at UCSB [Chakraborty et al., Appl. Phys. Lett. 85 (22) 5143 (2004)] very recently demonstrated the significant benefits of growth of reduced defect density α -plane InGaIn/GaN devices utilizing low defect-density HVPE grown α -plane GaN templates. This body of literature has established that nonpolar III-nitride light emitting diodes (LEDs) and laser diodes (LDs) have the potential to perform significantly better compared to their polar counterparts.

Bulk crystals of GaN are not available so it is not possible to simply cut a crystal to present a surface for subsequent device regrowth. All GaN films are initially grown heteroepitaxially, i.e. on foreign substrates that provide a reasonable lattice match to GaN. In recent years, a number of groups have found it possible to utilize HVPE as a means of heteroepitaxially depositing GaN films that are thick enough (>200 μ m) to remove the foreign substrate, yielding a free-standing GaN substrate that may then be used for homoepitaxial device regrowth. HVPE has the advantage of growth rates that are one to two orders of magnitude greater than that of MOCVD and as many as three orders of magnitude greater than MBE, an advantage that makes it an attractive technique for substrate fabrication.

One significant disadvantage of heteroepitaxial growth of nitrides is that structural defects are generated at the interface between the substrate and epitaxial film. The two predominant types of extended defects of concern are threading dislocations and stacking faults. The primary means of achieving reduced dislocation and stacking fault densities in polar c-plane GaN films is the use of a variety of lateral overgrowth techniques, including lateral epitaxial overgrowth (LEO, ELO, or ELOG), selective area epitaxy, and PENDEO® epitaxy. The essence of these processes is to block or discourage dislocations from propagating perpendicular to the film surface by favoring lateral growth over vertical growth. These dislocation-reduction techniques have been extensively developed for c-plane GaN growth by HVPE and MOCVD.

Only recently have GaN lateral growth techniques been demonstrated for α -plane films. Craven, et al. [Craven et al., Appl. Phys. Lett. 81 (7) 1201 (2002)], succeeded in performing LEO using a dielectric mask on a thin α -plane GaN template layer via MOCVD. Our group [Haskell et al., Appl. Phys. Lett. 83 (4) 644 (2003)] subsequently developed a LEO technique for the growth of α -plane GaN by HVPE. However, to date no such process has been developed or demonstrated for m-plane GaN.

The present invention overcomes these challenges and for the first time provides a technique for the growth of high-quality m-plane GaN by HVPE.

SUMMARY OF THE INVENTION

The present invention provides a method of growing highly planar, fully transparent and specular m-plane GaN films. The method provides for a significant reduction in structural defect densities via a lateral overgrowth technique. High quality, uniform, thick m-plane GaN films are produced for use as substrates for polarization-free device growth.

BRIEF DESCRIPTION OF THE DRAWINGS

Referring now to the drawings in which like reference numbers represent corresponding parts throughout:

FIG. 1 is a schematic of a generic hexagonal crystal structure and crystal planes of interest.

FIG. 2 is a flowchart that illustrates the steps of performing a direct growth of planar m-plane GaN films by hydride vapor phase epitaxy according to the preferred embodiment of the present invention.

FIG. 3(a) is a Nomarski optical contrast micrograph of an m-plane GaN film grown on a LiAlO₂ substrate, demonstrating the uniform and smooth surface morphology achieved with the present invention, and FIG. 3(b) is an atomic force micrograph of the same surface.

FIG. 4 is a flowchart that illustrates the steps of reducing threading dislocation and defect densities in the planar m-plane GaN films through a lateral epitaxial overgrowth of the GaN films according to the preferred embodiment of the present invention.

FIG. 5(a) is a schematic of the m-plane GaN lateral epitaxial overgrowth process using <0001>-oriented SiO₂ stripes, and FIG. 5(b) is a schematic of the m-plane GaN lateral growth process using (11 $\bar{2}$ 0)-oriented SiO₂ stripes.

FIG. 6(a) is an inclined cross section view of <0001>-oriented m-plane GaN lateral epitaxial overgrowth stripes, and FIG. 6(b) is a cross section view of (11 $\bar{2}$ 0)-oriented GaN stripes.

FIGS. 7(a) and 7(c) are plan view scanning electron microscopy images of coalesced lateral epitaxial overgrowth stripes grown from <0001> and (11 $\bar{2}$ 0)-oriented stripes, respectively. FIGS. 7(b) and 7(d) are corresponding cathodoluminescence images of the surfaces shown in FIGS. 7(a) and 7(c), revealing the window and wing regions. FIG. 7(e) is a cross sections SEM image of an m-plane GaN stripe oriented along the <0001> direction. FIG. 7(f) is the CL image corresponding to the stripe shown in FIG. 7(e).

FIGS. 8(a), 8(b), and 8(c) are 5×5 μm atomic force micrographs of m-plane GaN surfaces, wherein FIG. 8(a) shows a surface grown using the technique described in the first portion of this disclosure without defect reduction, and FIGS. 8(b) and 8(c) show surfaces from wings of lateral epitaxial overgrown m-plane GaN film grown with the present invention.

DETAILED DESCRIPTION OF THE INVENTION

In the following description of the preferred embodiment, reference is made to the accompanying drawings which form a part hereof, and in which is shown by way of illustration a specific embodiment in which the invention may be practiced. It is to be understood that other embodiments may be utilized and structural changes may be made without departing from the scope of the present invention.

Overview

Growth of non-polar m-plane {1T00} nitride semiconductors offers a means of eliminating polarization effects in würtzite-structure III:nitride device structures. Current (Ga, Al,In,B)N devices are grown in the polar [0001] c-direction, which results in charge separation along the primary conduction direction in optoelectronic devices. The resulting polarization fields are detrimental to the performance of current state of the art devices. Growth of these devices along a non-polar direction could improve device performance significantly.

Previous efforts to grow thick films of m-plane GaN yielded highly defective epilayers, containing high densities of bulk defects such as pits, notches, and cracks. These films also were extremely inhomogeneous and unsuitable for use as substrates in homoepitaxial device layer regrowth. This invention solves previously observed problems in the growth

of thick non-polar m-plane GaN films, including the elimination of pits, V-shaped defects, arrowhead defects, threading dislocations, and stacking faults. The present invention demonstrates, for the first time, the feasibility of growing highly planar, fully transparent and specular m-plane GaN films. Furthermore, this invention provides for a significant reduction in structural defect densities via a lateral overgrowth technique. This invention allows for the first time high quality, uniform, thick m-plane GaN films to be produced for use as substrates for polarization-free device growth.

The present invention provides a comparatively simple means of producing high-quality, low-defect density non-polar m-plane {1T00} GaN. Presently, GaN films must be grown heteroepitaxially due to the unavailability of bulk crystals, and no perfectly lattice-matched substrates exist for this growth process. As a result of the lattice mismatch in conventional heteroepitaxial growth, the resulting GaN films are inherently defective, generally containing dislocation densities in excess of 10⁸ cm⁻². A class of growth techniques that utilize lateral overgrowth has been developed for c-plane (0001) and more recently for α-plane {11 $\bar{2}$ 0} GaN growth, allowing significant reduction in dislocation density. The present invention offers a substantial improvement in film quality for m-plane GaN epilayers grown on foreign substrates, and additionally provides the first-ever successful execution of lateral overgrowth of m-plane GaN by any growth technique. As a result of this invention, it is now possible to grow significantly reduced-defect density, thick non-polar m-plane GaN films that may be subsequently used for the growth of improved electronic and optoelectronic devices by a variety of growth techniques.

Technical Description

The present invention provides a method for the fabrication of planar m-plane GaN films and free-standing layers via HVPE. By utilizing reduced growth pressures and a carrier gas containing a fraction of hydrogen, the present invention has demonstrated the stabilization and growth of nonpolar m-plane GaN directly off of a foreign substrate. The present invention further offers a method for reducing the threading dislocation and stacking fault densities in m-plane GaN through lateral overgrowth from a substrate through a mask layer.

Direct Growth of Planar m-plane GaN

The present invention provides for the direct growth of planar m-plane GaN films by HVPE for the first time. The growth process resembles that for α-plane GaN growth described in International Patent Application No. PCT/US03/21916, filed Jul. 15, 2003, by Benjamin A. Haskell, Paul T. Fini, Shigemasa Matsuda, Michael D. Craven, Steven P. DenBaars, James S. Speck, and Shuji Nakamura, entitled "GROWTH OF PLANAR, NON-POLAR A-PLANE GALLIUM NITRIDE BY HYDRIDE VAPOR PHASE EPITAXY," which application claims priority to U.S. Provisional Patent Application Ser. No. 60/433,844, filed Dec. 16, 2002, by Benjamin A. Haskell, Paul T. Fini, Shigemasa Matsuda, Michael D. Craven, Steven P. DenBaars, James S. Speck, and Shuji Nakamura, entitled "TECHNIQUE FOR THE GROWTH OF PLANAR, NON-POLAR A-PLANE GALLIUM NITRIDE BY HYDRIDE VAPOR PHASE EPITAXY," both of which applications are incorporated by reference herein.

This invention applies to a variety of growth sequences for the fabrication of {1T00} GaN by HVPE. Conventional metal-source HVPE involves the reaction of a halide compound, such as (but not limited to) gaseous hydrogen chloride (HCl), with metallic gallium at a temperature in excess of 700° C., to form gallium monochloride (GaCl). The GaCl is

transported to a substrate by a carrier gas, generally nitrogen, hydrogen, helium, or argon. Either in transport to the substrate, at the substrate, or in the exhaust stream, the GaCl reacts with ammonia (NH₃), forming GaN. Reactions that occur at the substrate have the potential to yield GaN on the substrate/growing film surface, resulting in crystal growth.

The present invention relies on the use of a combination of several growth parameters to achieve planar GaN films:

1. The use of a suitable substrate, such as, but not limited to, m-plane 6H—SiC, m-plane 4H—SiC, (100) γ -LiAlO₂, or any of the aforementioned substrates covered by an m-(In,Al,Ga,B)N template layer. The present invention has been successfully demonstrated with all of these substrates.

2. Use of a fraction of hydrogen (H₂) as a carrier gas for the final growth stage in one or more of the gas streams in the reactor;

3. A reduced reactor pressure, below atmospheric pressure (760 Torr), for the final step/stage of film deposition.

Process Steps

FIG. 2 is a flowchart that illustrates the steps of performing a direct growth of planar m-plane GaN films by hydride vapor phase epitaxy according to the preferred embodiment of the present invention. These steps comprise a typical growth sequence that yields high-quality, planar, m-plane GaN films using a conventional three-zone horizontal directed-flow HVPE system. The precise sequence will vary depending on the choice of substrate as described below.

Block 200 represents the step of loading a substrate into a reactor without any ex situ cleaning. In the preferred embodiment, the substrate is an m-plane 6H—SiC, m-plane 4H—SiC, or (100) γ -LiAlO₂ substrate, or any of the aforementioned substrates covered by an m-(In,Al,Ga,B)N template layer.

Block 202 represents the step of evacuating the reactor and backfilling the reactor with purified nitrogen (N₂) gas to reduce oxygen and water vapor levels therein, before heating the reactor. This step is typically repeated to further reduce the oxygen and water vapor presence in the system.

Block 204 represents the step of heating the reactor to a growth temperature of approximately 1040° C., with a mixture of H₂ and N₂ flowing through all channels in the system. If the substrate is coated with an m-plane (In,Al,Ga,B)N template layer, it is generally desirable to include a fraction of NH₃ in the gas stream during the reactor heating stage to prevent decomposition of the template. Also, when a template layer is used, superior film quality may be achieved by executing block 208, the pressure reduction step, prior to block 204.

Block 206 represents the step of nitridating the substrate, once the reactor reaches the growth temperature, wherein the nitridating step comprises adding anhydrous ammonia (NH₃) to a gas stream in the reactor to nitridate the surface of the substrate. The step of nitridating the substrate is performed at a temperature in excess of 900° C. This step is highly desirable when using LiAlO₂ substrates, but generally undesirable when using SiC substrates and may be omitted when SiC substrates are used.

Block 208 represents the step of reducing the reactor's pressure to a desired deposition pressure. In the preferred embodiment, the desired deposition pressure is below atmospheric pressure (760 Torr), and more specifically, the desired deposition pressure ranges from 5 to 100 Torr. In the preferred embodiment, the desired deposition pressure is approximately 76 Torr.

Block 210 represents the step of initiating a gaseous hydrogen chloride (HCl) flow to a gallium (Ga) source to begin growth of the m-plane GaN film directly on the substrate

without the use of any low-temperature buffer or nucleation layers. Conventional metal source HVPE involves an in situ reaction of a halide compound, such as (but not limited to), gaseous HCl with the metallic Ga at a temperature in excess of 700° C. to form a metal halide species, such as gallium monochloride (GaCl).

Block 212 represents the step of transporting the GaCl to the substrate by a carrier gas that includes at least a fraction of hydrogen (H₂) in one or more of the gas streams in the reactor. The carrier gas may also include nitrogen, helium, or argon, or other non-reactive noble gases. Either in transport to the substrate, at the substrate, or in an exhaust stream, the GaCl reacts with the NH₃ to form the GaN film. Reactions that occur at the substrate have the potential to yield the GaN film on the substrate, thereby resulting in crystal growth. Typical V/III ratios (the molar ratio of NH₃ to GaCl) are 1-50 for this process. Note that the NH₃/HCl ratio need not equal the V/III ratio due to supplemental HCl injection downstream of the Ga source or incomplete reaction of HCl with the Ga source.

Block 214 represents, after a desired growth time has elapsed, the step of interrupting the gaseous HCl flow, returning the reactor pressure, and reducing the reactor's temperature to room temperature. The interrupting step further comprises including NH₃ in a gas stream to prevent decomposition of the GaN film during the reduction of the reactor's temperature. The reactor pressure may be returned to atmospheric pressure or held at a lower pressure, e.g., wherein the cooling is performed between 5 and 760 Torr.

Typical growth rates for the GaN film range from 1 to 400 μ m per hour by this process. These growth rates are dependent on a number of growth parameters, including, but not limited to, the source and substrate temperatures, flow rates of the various gases into the system, the reactor geometry, etc., and can be varied over reasonably wide ranges while still yielding planar m-plane GaN films. The preferred values for most of these parameters will be specific to the growth reactor geometry.

The reference in the process steps above to the "final growth stage" refers to the observation that it is possible to planarize otherwise rough or defective films by concluding the growth stage with a step of suitable duration using the above-described conditions. The earlier stages of growth may incorporate any growth parameters that yield nominally m-plane oriented material, regardless of film quality or morphology.

Preferably, the above process steps create a planar, m-plane GaN film. Moreover, devices manufactured using this method include laser diodes, light-emitting diodes and transistors.

Experimental Results

The combination of the above-identified growth parameters has consistently yielded planar m-plane GaN films. FIG. 3(a) shows a Nomarski optical contrast micrograph of an m-plane GaN film grown on a (100) γ -LiAlO₂ substrate. This sample was grown using 32% N₂, 58% H₂, and the balance NH₃ and HCl with a V:III ratio of 15.8. The growth pressure was 70 Torr, and the substrate temperature was 862° C. The image is free of bulk defects, such as pits and cracks, that are characteristic of m-plane GaN films previously grown without this invention. The surface exhibits a non-crystallographic, flowing morphology with small nanometer-scale undulations. FIG. 3(b) shows an atomic force micrograph (AFM) image of this same sample. The striated morphology is commonly observed in MBE-grown m-plane GaN films, although this surface is markedly smoother than any previously reported. The scalloped morphology in the lower right quadrant of the AFM image has not previously been reported in the literature. This morphology may be related to the pres-

ence of screw-character threading dislocations in the film. The root-mean-square (RMS) roughness of this surface is 14.1 Å over a 25 μm² area, comparable to α-plane GaN films grown on r-plane Al₂O₃ by the same technique.

Lateral Epitaxial Overgrowth of m-plane GaN

The above described technique offers the first means to grow planar m-plane GaN films by HVPE. However, while these films are smooth and flat, they still contain a high density of threading dislocations and basal plane stacking faults. Indeed, transmission electron microscopy (TEM) of such direct growth samples has established that the threading dislocation and stacking fault densities are 4×10⁹ cm⁻² and 2×10⁵ cm⁻¹, respectively. The presence of such structural defects will degrade device performance compared to that which may be achieved using reduced defect density m-plane GaN. The present invention further includes a method for reducing the structural defect density in m-plane GaN films via LEO.

The present invention follows closely the technique developed for defect reduction in α-plane GaN films disclosed in International Patent Application No. PCT/US03/21918, filed Jul. 15, 2003, by Benjamin A. Haskell, Michael D. Craven, Paul T. Fini, Steven P. DenBaars, James S. Speck, and Shuji Nakamura, entitled "GROWTH OF REDUCED DISLOCATION DENSITY NON-POLAR GALLIUM NITRIDE BY HYDRIDE VAPOR PHASE EPITAXY," which application claims priority to U.S. Provisional Patent Application Ser. No. 60/433,843, filed Dec. 16, 2002, by Benjamin A. Haskell, Michael D. Craven, Paul T. Fini, Steven P. DenBaars, James S. Speck, and Shuji Nakamura, entitled "GROWTH OF REDUCED DISLOCATION DENSITY NON-POLAR GALLIUM NITRIDE BY HYDRIDE VAPOR PHASE EPITAXY," both of which applications are incorporated by reference herein.

The present invention relies on several key elements:

1. The use of a suitable substrate or template, such as, but not limited to, an m-plane GaN template grown on an AlN buffer layer on m-plane SiC.

2. Deposition of a porous mask on the template or substrate. This mask may be either uniform, as in the deposition and patterning of a dielectric layer; or inhomogeneous, as in the case of the deposition of a thin, porous metallic or ceramic mask. The mask may be deposited by a variety of in situ or ex situ techniques.

3. Deposition of (Al,B,In,Ga)N at a reduced pressure (less than 760 Torr).

4. Use of a majority of H₂ in the gas stream to which the substrate/template is exposed during the growth.

Process Steps

FIG. 4 is a flowchart that illustrates the steps of reducing threading dislocation and defect densities in the planar m-plane GaN films through a lateral epitaxial overgrowth of the GaN films according to the preferred embodiment of the present invention. These steps comprise patterning a mask deposited on a substrate (Blocks 400-408 below), and performing a LEO growth of the GaN film off the substrate using HVPE (Blocks 410-420 below), wherein the GaN film nucleates only on portions of the substrate not covered by the patterned mask, the GaN film grows vertically through openings in the patterned mask, and the GaN film then spreads laterally above the patterned mask and across the substrate's surface.

Block 400 represents the step of depositing a ~1350 Å-thick SiO₂ film on a suitable substrate or template, such as, but not limited to, an m-plane GaN template grown by MBE on an AlN buffer layer on an m-plane 6H-SiC substrate, wherein the SiO₂ film provides the basis for the dielectric

mask. Although, in the preferred embodiment, the patterned mask is a dielectric, and the substrate is an m-plane 6H-SiC substrate, other materials may be used as well, such as a metallic material for the patterned mask or sapphire for the substrate.

Block 402 represents the step of depositing a photoresist layer on the SiO₂ film and patterning the deposited photoresist layer using conventional photolithography processing steps. In one embodiment, the pattern comprises 35 μm wide stripes separated by 5 μm wide openings.

Block 404 represents the step of etching away any portions of the SiO₂ film exposed by the patterned photoresist layer by soaking the substrate in buffered hydrofluoric (HF) acid for two minutes.

Block 406 represents the step of removing remaining portions of the photoresist layer using acetone.

Block 408 represents the step of cleaning the substrate using acetone, isopropyl alcohol, and deionized water.

After drying, the substrate is covered by a patterned mask comprising the patterned SiO₂ film having 35 μm wide stripes separated by 5 μm wide openings.

Preferably, the mask is porous. Moreover, the mask may be either uniform, as in the deposition and patterning of a dielectric layer; or inhomogeneous, as in the case of the deposition of a thin, porous metallic or ceramic mask. The mask may be deposited by a variety of in situ or ex situ techniques.

The following Blocks represent the steps of performing a lateral epitaxial overgrowth of the GaN film off the substrate using HVPE, wherein the GaN film nucleates only on portions of the substrate exposed by the patterned mask, the GaN film grows vertically through openings in the patterned mask, and the GaN film then spreads laterally above the patterned mask and across the substrate's surface, eventually converging with adjacent GaN stripes. The lateral epitaxial overgrowth utilizes reduced growth pressures of approximately atmospheric pressure (760 Torr) and a carrier gas containing a fraction of hydrogen. The growth conditions for the lateral growth process are very similar to those described above for high-quality planar m-plane GaN growth via HVPE.

These steps, and the growth parameters therefor, are described in more detail in the co-pending and commonly-assigned International Application No. PCT/US03/21916, entitled "GROWTH OF PLANAR, NON-POLAR A-PLANE GALLIUM NITRIDE BY HYDRIDE VAPOR PHASE EPITAXY," filed on Jul. 15, 2003, by Benjamin A. Haskell, Paul T. Fini, Shigemasa Matsuda, Michael D. Craven, Steven P. DenBaars, James S. Speck, and Shuji Nakamura, which application claims priority to co-pending and commonly-assigned U.S. Provisional Patent Application Ser. No. 60/433,844, entitled "TECHNIQUE FOR THE GROWTH OF PLANAR, NON-POLAR A-PLANE GALLIUM NITRIDE BY HYDRIDE VAPOR PHASE EPITAXY," filed on Dec. 16, 2002, by Benjamin A. Haskell, Paul T. Fini, Shigemasa Matsuda, Michael D. Craven, Steven P. DenBaars, James S. Speck, and Shuji Nakamura; and U.S. Provisional Patent Application Ser. No. 60/433,843, entitled "GROWTH OF REDUCED DISLOCATION DENSITY NON-POLAR GALLIUM NITRIDE BY HYDRIDE VAPOR PHASE EPITAXY," filed on Dec. 16, 2002, by Benjamin A. Haskell, Michael D. Craven, Paul T. Fini, Steven P. DenBaars, James S. Speck, and Shuji Nakamura; ALL OF which applications are incorporated by reference herein.

Block 410 represents the step of loading the substrate into a reactor.

Block 412 represents the step of evacuating the reactor and backfilling the reactor with purified nitrogen (N₂) gas to

reduce oxygen levels therein. This step is frequently repeated to further reduce residual oxygen levels within the reactor.

Block 414 represents the step of heating the reactor to a growth temperature of approximately 1040° C., with a mixture of H₂, N₂, and NH₃ flowing into a growth chamber at a reduced pressure. In the preferred embodiment, the desired deposition pressure is below atmospheric pressure (760 Torr), and is generally less than 300 Torr. More specifically, the desired deposition pressure may be restricted to a range of 5-100 Torr, and may be set to 76 Torr.

Block 416 represents the step of initiating a gaseous hydrogen chloride (HCl) flow to a gallium (Ga) source to begin growth of the m-plane GaN film directly on the substrate without the use of any low-temperature buffer or nucleation layers. Conventional metal source HVPE involves an in situ reaction of a halide compound, such as (but not limited to), gaseous HCl with the metallic Ga at a temperature in excess of 700° C. to form gallium monochloride (GaCl).

Block 418 represents the step of transporting the GaCl to the substrate by a carrier gas that includes at least a fraction of hydrogen (H₂) in one or more of the gas streams in the reactor. In one embodiment, the carrier gas may be predominately hydrogen, while in other embodiments, the carrier gas comprises a mixture of hydrogen and nitrogen, argon, helium or other inert gases. Either in transport to the substrate, at the substrate, or in an exhaust stream, the GaCl reacts with the NH₃ to form the GaN film. Reactions that occur at the substrate have the potential to yield the GaN film on the substrate, thereby resulting in crystal growth. Typical V/III ratios are 1-50 for this process. Note that the NH₃/HCl ratio need not equal the V/III ratio due to supplemental HCl injection downstream of the Ga source or incomplete reaction of HCl with the Ga source.

Block 420 represents, after a desired growth time has elapsed, the step of interrupting the gaseous HCl flow, reducing the reactor's temperature to room temperature. The reactor will generally be held at low pressure until the substrate has dropped below 600° C., but the reactor pressure may optionally be returned to atmospheric pressure at this time. The interrupting step further comprises including NH₃ in a gas stream to prevent decomposition of the GaN film during the reduction of the reactor's temperature.

Preferably, the above process steps create lateral epitaxial overgrowth of a planar, m-plane GaN film off the template. Moreover, the above process steps are used to manufacture a free-standing m-plane GaN film or substrate. However, the present invention may encompass the deposition of any (Al, B, In, Ga)N films. Moreover, devices manufactured using this method include laser diodes, light-emitting diodes and transistors.

Experimental Results

In a demonstration of the present invention, m-plane GaN templates were grown on m-plane 6H-SiC using AlN buffer layers grown by MBE. A 1350 Å-thick SiO₂ layer was then deposited on the GaN template surface. Conventional photolithographic techniques and wet etching in a 5% HF solution were used to pattern an array of parallel stripe openings in the SiO₂ layer. In the initial experiments, these parallel stripes were oriented along either the GaN [0001] or [11 $\bar{2}$ 0] directions. After ultrasonic cleaning of the wafers with acetone and isopropanol, the patterned wafers were loaded into a horizontal HVPE reactor. The samples were heated to deposition temperatures ranging from 850 to 1075° C. in an ambient of 52% N₂, 42% H₂, and 6% NH₃ at a pressure of 62.5 Torr. Once the samples had reached the desired growth temperature, the gas flow into the reactor was changed to 38% N₂, 57% H₂, and the balance NH₃ and HCl with a V:III ratio of 13.1. After the

desired growth time, the HCl flow into the reactor was halted and the furnace shut off, with the samples being cooled to below 600° C. at the reduced pressure with NH₃ present. Below 600° C., the ambient was switched exclusively to N₂ and the samples were cooled to room temperature.

A schematic of the lateral epitaxial overgrowth process using parallel mask stripes oriented along the <0001> direction is shown in FIG. 5(a), which includes a substrate/template 500, SiO₂ mask 502 and m-plane GaN surfaces 504. During the growth process, the m-plane GaN film 504 grows only from the regions of exposed substrate/template material 500 and spreads laterally above the mask 502 and across the substrate 500 surface. The laterally growing GaN film 504 will exhibit reduced threading dislocation densities in the wing regions 508 compared to the GaN 504 growing vertically from the exposed window 506 region. FIG. 5(b) shows the corresponding process for a mask geometry 502 of parallel stripes aligned instead along the <11 $\bar{2}$ 0> direction. In this geometry, two asymmetrical wings will form. The Ga-face wing 510 will be free of both threading dislocations and stacking faults, while the N-face wing 512 and 514 will be free of threading dislocations but not stacking faults. In both cases, threading dislocations will be eliminated in the overgrown material 504 even if they are present in the window material.

An example of several m-plane GaN stripes grown by this technique is shown in FIG. 6(a). These stripes have grown through 5 μm-wide windows in a SiO₂ mask oriented along the <0001> direction and have spread laterally to a width of approximately 40 μm. If this growth had been continued for a sufficient time, these stripes would have converged with adjacent stripes to form a continuous m-plane GaN surface, such as the one shown in FIG. 7(a). The coalesced film will have lower dislocation densities in the overgrown regions due to blocking and bending of dislocations through the transition from vertical to lateral growth. This reduced defect density is confirmed by panchromatic cathodoluminescence (CL) in FIG. 7(b). The CL image reveals the dark, defective window regions and brighter, laterally overgrown wing regions. The overgrown material exhibits more intense luminescence due to the reduced dislocation density in the overgrown material. Thus, the invention offers an effective means of reducing the structural defect density in nonpolar m-plane GaN films. Dislocation bending can be further observed in the cross-sectional SEM and CL images in FIG. 7(e) and (f).

A second example of m-plane GaN LEO stripes is shown in FIG. 6(b), in this case using parallel SiO₂ stripes oriented along the <11 $\bar{2}$ 0> direction. In contrast to the stripes shown in FIG. 6(a), stripes oriented along the <11 $\bar{2}$ 0> direction exhibit vertical c-plane sidewalls and asymmetrical lateral growth rates. The Ga-face wing will be free of dislocations and stacking faults, while the N-face wing will be free of dislocations only. A smooth, coalesced film grown with <11 $\bar{2}$ 0>-oriented stripes is shown in FIG. 7(c). The reduced defect densities are again apparent in the plan view CL image shown in FIG. 7(d), with the defective window regions appearing dark and the reduced defect density wing regions being bright. Note that even through the N-face wing contains stacking faults, its luminescence is much greater than that of the window region as stacking faults do not significantly detract from radiative recombination efficiency in GaN.

FIGS. 8(a), 8(b) and 8(c) offer a comparison of local surface morphology with and without the defect reduction technique offered by the present invention. FIG. 8(a) shows an AFM image of the smoothest m-plane GaN film that has been grown without any form of defect reduction. This surface is significantly smoother than any surface previously reported

in the scientific literature, with an RMS roughness of 8 Å over a 25 μm² area. The AFM image shown in FIG. 7(b) is also a 5×5 μm image of an m-plane GaN surface, taken from the laterally overgrown region of a sample grown with <0001>-oriented stripes according to the present invention. The scallops due to dislocation terminations have been eliminated, and the surface roughness has been reduced to 6 Å. This roughness is on par with very high-quality polar c-plane GaN films. FIG. 8(c) shows another AFM image of an m-plane GaN films, in this case from one of the laterally overgrown wings of an LEO sample that incorporated parallel SiO₂ stripes oriented along the GaN <11 $\bar{2}$ 0> direction. The surface morphology is significantly more uniform, exhibiting a morphology that closely resembles that which is observed in the highest-quality c-plane GaN films. The RMS roughness of this surface is only 5.31 Å, nearly a 34% reduction/improvement compared to the non-LEO surface. Thus, the present invention can be utilized to provide smoother m-plane GaN surfaces, which will lead to higher device quality.

The preferred embodiment of the present inventions for growth of high-quality m-plane GaN and the subsequent defect reduction therein includes:

1. Use of a suitable substrate, such as but not limited to (100) γ-LiAlO₂ or (1T00) SiC (any hexagonal polytype), or a template comprising an m-plane III-N film on a suitable substrate.
2. Use of a fraction of hydrogen as a carrier gas for the GaN deposition stage in one or more of the gas streams in the reactor.
3. Use of a reduced reactor pressure, below 760 Torr, for the GaN growth stage of film deposition.
4. Incorporation of defect reduction techniques involving deposition of a thin mask layer such as a 1300 Å-thick SiO₂ mask containing apertures or stripes allowing access to the underlying III-N template layer or substrate.
5. Growth of an m-plane GaN film through the mask layer, which spreads laterally to produce reduced defect density GaN.

As an example, a 1300 Å-thick SiO₂ film is deposited on a 500 μm thick polished m-plane SiC substrate that has previously been coated with an m-plane AlN film by MBE. Conventional photolithography processing is used to pattern a photoresist layer comprised of 35 μm-wide stripes separated by 5 μm-wide openings. The wafer is then soaked in buffered hydrofluoric acid for two minutes, completely etching away the exposed SiO₂. The remaining photoresist is removed with acetone and the wafer is cleaned in acetone, isopropyl alcohol, and deionized water. After drying, the wafer, which now comprises an m-plane AlN film on an m-plane SiC substrate that is covered by 35 μm-wide SiO₂ stripes separated by 5 μm-wide openings, is loaded into the reactor for growth. During the growth process, GaN nucleates only on the exposed AlN and grows vertically through the mask openings. The film then spreads laterally over the SiO₂ stripes, eventually converging with adjacent GaN stripes.

Possible Modifications and Variations

The preferred embodiment has described a method for growing planar m-plane GaN and then improving the quality of the m-plane GaN via a lateral overgrowth process. Several potential substrate materials have been proven effective the practice of this invention, including (100) γ-LiAlO₂, (1T00) 4H-SiC, and (1T00) 6H-SiC. Alternative suitable substrate materials, including, but not limited to, free-standing m-plane GaN, free-standing m-plane AlN, additional polytypes of SiC, miscut m-plane Al₂O₃, or miscut variants of any of the substrates previously mentioned, may potentially be used in practice of this invention. The substrate for the lateral

growth process may also comprise any suitable substrate for the growth of planar m-plane GaN, or any of the above substrates that has been coated with a template layer of GaN, AlN, AlGaN, or other template material. Nucleation layers deposited at either low temperatures or at the growth temperature by a variety of growth techniques may also be used for subsequent lateral overgrowth by HVPE using this technique. It should be noted that the choice of substrates will affect the optimal gas composition during the reactor heating stage. For some substrates, such as LiAlO₂, it is preferable to ramp in an atmosphere that includes ammonia, whereas SiC will be negatively affected by ramping with ammonia present. It may also be preferable to ramp to the growth temperature at low pressure, particularly when regrowing on GaN templates. Significant variations in ramp conditions may be made without deviating from the scope of the present invention.

Additionally, a variety of mask materials, mask deposition techniques, and patterning methods may be used in the practice of this invention without significantly altering the results of the invention. Such deposition approaches include, but are not limited to, evaporation of metallic masks (e.g., titanium or tungsten), sputter deposition of dielectric masks including a wide range of oxides and SiN_x, and chemical vapor deposition of oxide, nitride, or fluoride masks. The mask may be deposited via an ex situ technique as described above or may be deposited in situ. As an example, within a single three-source HVPE reactor, it is possible to deposit an AlN buffer on an m-SiC substrate, then grow a thin GaN film using the invention described herein, then deposit a thin SiN_x mask layer through with reduced defect density m-plane GaN may be grown. The mask in this instance would consist of irregular islands of SiN_x but would serve the same purpose as a uniform mask prepared through photolithography. Alternatively, a Ti metal film could be evaporated on a free-standing m-plane GaN substrate, loaded into the HVPE growth system, and annealed in NH₃ to form a similarly porous mask layer.

Another alternative approach is to etch a pattern into the substrate or template material rather than deposit a patterned mask on the substrate by, for example, reactive ion etching. In such an approach, the depth and width of the trenches in the substrate should be chosen such that the film growing laterally from the unetched plateaus coalesce before the GaN growing from the bottom of the trenches reaches the top of the trenches. This technique, known as cantilever epitaxy, has been demonstrated for polar c-plane GaN growth, and should be compatible with the present invention. The upper surfaces of the substrate or template pillars that remain may be left uncoated, as in cantilever epitaxy, or may be coated with a mask material to encourage growth from the exposed sidewalls, as in sidewall lateral epitaxial overgrowth.

The geometry of the dielectric mask described in the significantly affects the behavior of the laterally-growing film. In establishing the validity of the present invention, masks containing stripes with various orientations relative to the substrate were used. While the growth behavior from each shape opening differs, it has been shown that the choice of mask geometry does not fundamentally alter the practice of this invention. Thus, any mask containing some regions where GaN nucleation is preferred and some regions where GaN nucleation is discouraged is acceptable, irrespective of geometry.

Reactor geometry and design may affect the practice of this invention. The growth parameters required for the successful lateral overgrowth of non-polar GaN may vary from reactor to reactor. Such variations do not fundamentally alter the general practice of this invention.

Additionally, while in general it is desirable to continue the lateral growth process to the point of film coalescence, coalescence is not a requirement for the practice of this invention. The present inventors have envisioned a number of applications in which uncoalesced laterally-overgrown nonpolar GaN stripes or pillars would be highly desirable. Therefore, this disclosure applies to both coalesced and uncoalesced laterally-overgrown non-polar GaN films.

The present invention has focused on the growth of planar m-plane GaN by HVPE. However, this invention is also applicable to the growth of m-plane III-N alloys, including, but not limited to, InGaN and AlGaIn. The incorporation of a fraction of Al, In, or B in the nonpolar GaN films does not fundamentally alter the practice of the invention. In general, in the above discussion, any mention of "GaN" may be replaced by the more general nitride composition $Al_xIn_yGa_zB_nN$ in which $0 \leq x \leq 1$, $0 \leq y \leq 1$, $0 \leq z \leq 1$, $0 \leq n \leq 1$, and $x+y+z+n=1$. Also, additional dopants, such as, but not limited to, Si, Zn, Mg, and Fe, can be incorporated into the films described in this invention without deviating from its scope.

The practice of this invention may include multiple growth steps at varying temperatures and or pressures, or having different nitride compositions. Such multi-step growth processes are fundamentally compatible the invention described herein.

Furthermore, this invention has described a growth technique utilizing HVPE. Our research on the growth of nonpolar III-N films has firmly established that using simple modifications, the techniques for lateral overgrowth of GaN described herein may be adapted to the growth of m-GaN by MOCVD as well.

Advantages and Improvements

This invention represents the first known reports of planar, high-quality nonpolar m-plane GaN and of lateral overgrowth of m-plane GaN by HVPE. The literature contains no previous reports of lateral growth of m-plane GaN by any technique.

The application of low-pressure growth utilizing a majority fraction of hydrogen carrier gas enabled for the first time the growth of planar m-plane GaN films by HVPE. The present invention expands on this discovery by allowing significant defect reduction and film quality improvement compared to nonpolar GaN films grown heteroepitaxially on substrates. Such reduced defect density nonpolar GaN will provide for improvements in the electronic, optoelectronic, and electro-mechanical devices that are subsequently grown on the template films grown by this technique. The laterally overgrown films described herein further provide an excellent means of reducing the dislocation density in thick non-polar GaN films that can be debonded to form free-standing substrates.

REFERENCES

The following references are incorporated by reference herein:

1. R. R. Vanfleet, et al., "Defects in m-face GaN films grown by halide vapor phase epitaxy on $LiAlO_2$," Appl. Phys. Lett., 83 (6) 1139 (2003).

2. P. Waltereit, et al., "Nitride semiconductors free of electrostatic fields for efficient white light-emitting diodes," Nature (406) 865 (2000).

3. Y. Sun et al., "In surface segregation in M-plane (In,Ga)N/GaN multiple quantum well structures," Appl. Phys. Lett. 83 (25) 5178 (2003).

4. Gardner et al., "Polarization anisotropy in the electroluminescence of m-plane InGaIn-GaN multiple-quantum-well light-emitting diodes," Appl. Phys. Lett. 86, 111101 (2005).

5. Chitnis et al., "Visible light-emitting diodes using α -plane GaN-InGaIn multiple quantum wells over r-plane sapphire," Appl. Phys. Lett. 84 (18) 3663 (2004).

6. Chakraborty et al., "Nonpolar InGaIn/GaN emitters on reduced-defect lateral epitaxially overgrown α -plane GaN with drive-current-independent electroluminescence emission peak," Appl. Phys. Lett. 85 (22) 5143 (2004).

7. Craven et al., "Threading dislocation reduction via laterally overgrown nonpolar (11-20) α -plane GaN," Appl. Phys. Lett. 81 (7) 1201 (2002).

8. Haskell et al., "Defect reduction in (11-20) α -plane gallium nitride via lateral epitaxial overgrowth by hydride vapor phase epitaxy," Appl. Phys. Lett. 83 (4) 644 (2003).

CONCLUSION

This concludes the description of the preferred embodiment of the present invention. The foregoing description of one or more embodiments of the invention has been presented for the purposes of illustration and description. It is not intended to be exhaustive or to limit the invention to the precise form disclosed. Many modifications and variations are possible in light of the above teaching. It is intended that the scope of the invention be limited not by this detailed description, but rather by the claims appended hereto.

What is claimed is:

1. A device having a structure that includes a lateral epitaxial overgrowth layer grown in a non-polar direction and having a top surface that is non-polar, the lateral epitaxial overgrowth layer comprising a non-polar III-nitride film with a reduction in dislocation density as compared to III-nitride films grown heteroepitaxially containing dislocation densities in excess of 10^8 cm^{-2} .

2. The device of claim 1, wherein the device is a spontaneous and piezoelectric polarization-free device.

3. The device of claim 1, wherein the lateral epitaxial overgrowth layer resides on a surface of a direct growth layer, the direct growth layer comprising a III-nitride film.

4. The device of claim 1, wherein the non-polar III-nitride film is a planar film.

5. The device of claim 1, wherein the non-polar III-nitride film is an m-plane gallium nitride (GaN) film.

6. The device of claim 1, wherein the non-polar III-nitride film contains dislocation densities less than 10^8 cm^{-2} .

7. The device of claim 1, wherein the device is a laser diode, light-emitting diode or transistor.

* * * * *