



(12) **EUROPEAN PATENT APPLICATION**  
 published in accordance with Art. 158(3) EPC

(43) Date of publication:  
**01.12.2004 Bulletin 2004/49**

(51) Int Cl.7: **C22C 45/02, H01F 1/14**

(21) Application number: **03707143.8**

(86) International application number:  
**PCT/JP2003/002257**

(22) Date of filing: **27.02.2003**

(87) International publication number:  
**WO 2003/074749 (12.09.2003 Gazette 2003/37)**

(84) Designated Contracting States:  
**AT BE BG CH CY CZ DE DK EE ES FI FR GB GR  
 HU IE IT LI LU MC NL PT SE SI SK TR**

(72) Inventor: **Inoue, Akihisa**  
**Aoba-ku Sendai-shi, Miyagi 980-0861 (JP)**

(30) Priority: **01.03.2002 JP 2002055291**

(74) Representative: **Wagner, Karl H., Dipl.-Ing.**  
**Wagner & Geyer,**  
**Patentanwälte,**  
**Gewürzmühlstrasse 5**  
**80538 München (DE)**

(71) Applicant: **Japan Science and Technology  
 Agency**  
**Kawaguchi-shi, Saitama 332-0012 (JP)**

(54) **SOFT MAGNETIC METALLIC GLASS ALLOY**

(57) Disclosed is a soft magnetic Fe-B-Si-based metallic glass alloy with high glass forming ability which has a supercooled-liquid temperature interval ( $\Delta T_\chi$ ) of 40 K or more, a reduced glass-transition temperature ( $T_g/T_m$ ) of 0.56 or more and a saturation magnetization of 1.4 T or more. The metallic glass alloy is represented by the following composition formula:  $(Fe_{1-a-b} B_a Si_b)_{100-\chi} M_\chi$ , wherein a and b represent an atomic ratio, and satisfy the following relations:  $0.1 \leq a \leq 0.17$ ,  $0.06 \leq b \leq 0.15$  and  $0.18 \leq a + b \leq 0.3$ , M is one or more elements selected from the group consisting of Zr, Nb, Ta, Hf, Mo, Ti, V, Cr, Pd and W, and  $\chi$  satisfies the following relation:  $1 \text{ atomic\%} \leq \chi \leq 10 \text{ atomic\%}$ . The present invention overcomes restrictions in preparing a metallic glass bar with a thickness of 1 mm or more from conventional Fe-B-Si-based metallic glasses due to their poor glass forming ability, and provides a high saturation-magnetization Fe-B-Si-based metallic glass allowing the formation of bulk metallic glass, which serves as a key technology for achieving a broader application fields of metallic glass products.

**FIG. 2**

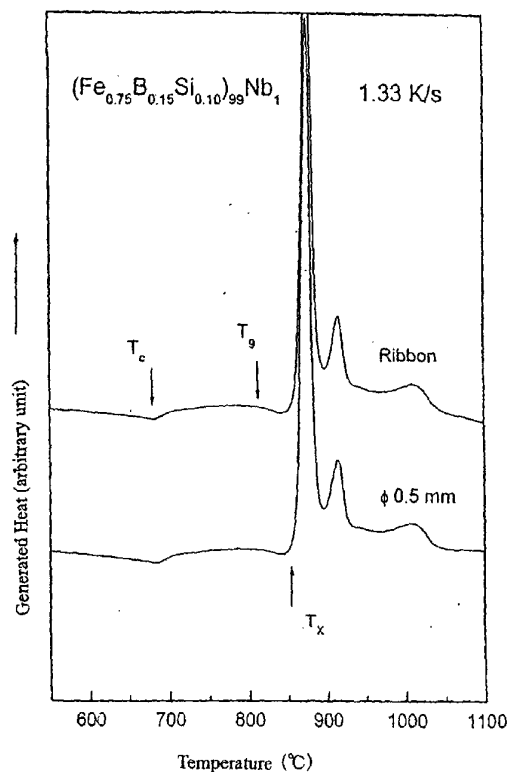

**Description**

## TECHNICAL FIELD

- 5 **[0001]** The present invention relates to a soft magnetic Fe-B-Si-based metallic glass alloy with high saturation magnetization and high glass forming ability.

## BACKGROUND ART

- 10 **[0002]** Conventional metallic glasses include Fe-P-C-based metallic glass which was first produced in the 1960s, (Fe, Co, Ni)-P-B-based alloy, (Fe, Co, Ni)-Si-B-based alloy, (Fe, Co, Ni)-(Zr, Hf, Nb)-based alloy and (Fe, Co, Ni)-(Zr, Hf, Nb)-B-based alloy which were produced in the 1970s.

- [0003]** All of the above alloys are essentially subjected to a rapid solidification process at a cooling rate of  $10^4$  K/s or more, and an obtained sample is a thin strip having a thickness of 200  $\mu\text{m}$  or less. Between 1988 and 2001, various metallic glass alloys exhibiting high glass forming ability, which have a composition, such as Ln-Al-TM, Mg-Ln-TM, Zr-Al-TM, Pd-Cu-Ni-P, (Fe, Co, Ni)-(Zr, Hf, Nb)-B, Fe-(Al, Ga)-P-B-C, Fe-(Nb, Cr, Mo)-(Al, Ga)-P-B-C, Fe-(Cr, Mo)-Ga-P-B-C, Fe-Co-Ga-P-B-C, Fe-Ga-P-B-C or Fe-Ga-P-B-C-Si (wherein Ln is a rare-earth element, and TM is a transition metal), were discovered. These alloys can be formed as a metallic glass bar having a thickness of 1 mm or more.

- 15 **[0004]** The inventor previously filed patent applications concerning a soft magnetic metallic glass alloy of Fe-P-Si-(C, B, Ge)-(group-IIIB metal element, group-IVB metal element) (Patent Publication 1); a soft magnetic metallic glass alloy of (Fe, Co, Ni)-(Zr, Nb, Ta, Hf, Mo, Ti, V)-B (Patent Publication 2); and a soft magnetic metallic glass alloy of Fe-(Cr, Mo)-Ga-P-C-B (Patent Publication 3).

Parent Publication 1: Japanese Patent Laid-Open Publication No. 11-71647

- 25 Parent Publication 2: Japanese Patent Laid-Open Publication No. 11-131199

Parent Publication 3: Japanese Patent Laid-Open Publication No. 2001-316782

## DISCLOSURE OF INVENTION

- 30 **[0005]** The inventor previously found out several soft magnetic bulk metallic glass alloys with a saturation magnetization of up to 1.4 T. However, in view of practical applications, it is desired to provide a soft magnetic metallic glass alloy having a saturation magnetization of 1.4 T or more.

- [0006]** Through researches on various alloy compositions in order to achieve the above object, the inventor found a soft magnetic Fe-B-Si-based metallic glass alloy composition exhibiting clear glass transition and wide supercooled liquid region and having higher glass formation ability and higher saturation magnetization, and has accomplished the present invention.

- [0007]** Specifically, the present invention provides a soft magnetic Fe-B-Si-based metallic glass alloy with high glass forming ability which has a supercooled-liquid temperature interval ( $\Delta T_{\chi}$ ) of 40 K or more, a reduced glass-transition temperature ( $T_g / T_m$ ) of 0.56 or more and a saturation magnetization of 1.4 T or more. The metallic glass alloy is represented by the following composition formula:  $(\text{Fe}_{1-a-b} \text{B}_a \text{Si}_b)_{100-\chi} \text{M}_{\chi}$ , wherein a and b represent an atomic ratio, and satisfy the following relations:  $0.1 \leq a \leq 0.17$ ,  $0.06 \leq b \leq 0.15$  and  $0.18 \leq a + b \leq 0.3$ , M is one or more elements selected from the group consisting of Zr, Nb, Ta, Hf, Mo, Ti, V, Cr, Pd and W, and  $\chi$  satisfies the following relation: 1 atomic%  $\leq \chi \leq 10$  atomic%.

- [0008]** In a metallic glass prepared using the alloy with the above composition through a single-roll rapid liquid cooling process in the form of thin strip (or film, ribbon) having a thickness of 0.2 mm or more, a supercooled-liquid temperature interval (or the temperature interval of a supercooled liquid region) ( $\Delta T_{\chi}$ ), which is expressed by the following formula:  $\Delta T_{\chi} = T_{\chi} - T_g$  (wherein  $T_{\chi}$  is a crystallization temperature, and  $T_g$  is a glass transition (vitrification) temperature), is 40 K or more, and a reduced glass-transition temperature ( $T_g / T_m$ ) is 0.56 or more.

- [0009]** During the course of preparing a metallic glass using the liquid alloy with the above composition through a copper-mold casting process, heat generation caused by significant glass transition and crystallization is observed in a thermal analysis. A critical thickness or diameter in glass formation is 1.5 mm. This proves that metallic glass can be prepared through a copper-mold. casting process.

- [0010]** In the above alloy composition of the present invention, a primary component or Fe is an element playing a role in creating magnetism. Thus, Fe is essentially contained in an amount of 64 atomic% or more to obtain high saturation magnetization and excellent soft magnetic characteristics, and may be contained in an amount of up to 81 atomic%.

- [0011]** In the above alloy composition of the present invention, metalloid elements B and Si play a role in forming an amorphous phase. This role is critical to obtain a stable amorphous structure. In  $\text{Fe}_{1-a-b} \text{B}_a \text{Si}_b$ , the atomic ratio of a +

b is set in the range of 0.18 to and 0.3, and the remainder is Fe. If the atomic ratio of a + b is outside this range, it is difficult to form an amorphous phase. It is required to contain both B and Si. If either one of B and Si is outside the above composition range, the glass forming ability is deteriorated to cause difficulties in forming a bulk metallic glass.

**[0012]** In the above alloy composition of the present invention, the addition of the element M is effective to provide enhanced glass forming ability. In the alloy composition of the present invention, the element M is added in the range of 1 atomic% to 10 atomic%. If the element M is outside this range and less than 1 atomic%, the supercooled-liquid temperature interval ( $\Delta T_{\chi}$ ) will disappear. If the element M is greater than 10 atomic%, the saturation magnetization will be undesirably reduced.

**[0013]** The Fe-B-Si-based alloy of the present invention may further contain 3 atomic% or less of one or more elements selected from the group consisting of P, C, Ga and Ge. The addition of the one or more elements allows a coercive force to be reduced from 3.5 A/m to 3.0 A/m, or provides enhanced soft magnetic characteristics. On the other hand, if the content of the one or more elements becomes greater than 3 atomic%, the saturation magnetization will be lowered as the content of Fe is reduced. Thus, the content of the one or more elements is set at 3 atomic% or less.

**[0014]** In the above alloy composition of the present invention, any deviation from the above defined composition ranges causes deteriorated glass forming ability to create/grow crystals during the process of solidification of liquid metals so as to form a mixed structure of a glass phase and a crystal phase. If the deviation from the composition range becomes larger, an obtained structure will have only a crystal phase without any glass phase.

**[0015]** The Fe-B-Si alloy of the present invention has high glass forming ability allowing a metallic glass round bar with a diameter of 1.5 mm to be prepared through a copper-mold casting process. Further, at the same cooling rate, a thin wire with a minimum diameter of 0.4 mm can be prepared through an in-rotating-water spinning process, and a metallic glass powder with a minimum particle diameter of 0.5 mm through an atomization process.

#### BRIEF DESCRIPTION OF DRAWINGS

##### **[0016]**

FIG 1 is an optical micrograph showing the sectional structure of a cast bar in one Inventive Example.

FIG 2 is a graph showing thermal analysis curves of a cast bar obtained in Inventive Example 1 and a ribbon obtained in Inventive Example 15.

FIG 3 is a graph showing thermal analysis curves of a cast bar obtained in Inventive Example 3 and a ribbon obtained in Inventive Example 16.

FIG 4 is a graph showing I-H hysteresis curves of the cast bar obtained in Inventive Example 1 and the ribbon obtained in Inventive Example 15, based on the measurement of their magnetic characteristics using a vibrating-sample magnetometer.

FIG 5 is a graph showing I-H hysteresis curves of the cast bar obtained in Inventive Example 3 and the ribbon obtained in Inventive Example 16, based on the measurement of their magnetic characteristics using a vibrating-sample magnetometer.

FIG 6 is a schematic side view of an apparatus for use in preparing an alloy sample of a cast bar through a copper-mold casting process.

#### BEST MODE FOR CARRYING OUT THE INVENTION

[Inventive Examples 1 to 14, Comparative Examples 1 to 7]

**[0017]** FIG 6 is a schematic side view of an apparatus used in preparing an alloy sample with a diameter of 0.5 to 2 mm through a copper-mold casting process. A molten alloy 1 having a given composition was first prepared through an arc melting process. The alloy 1 was inserted into a silica tube 3 having a front end formed with a small opening 2, and molten using a high-frequency coil 4. Then, the silica tube 3 was disposed immediately above a copper mold 6 formed with a vertical hole 5 having a diameter of 0.5 to 2 mm to serve as a casting space, and a given pressure (1.0 Kg/cm<sup>2</sup>) of argon gas was applied onto the molten metal 1 in the silica tube 3 to inject the molten metal 1 from the small opening 2 (diameter: 0.5) of the silica tube 3 into the hole 5 of the copper mold 6. The injected molten metal was left uncontrolled and solidified to obtain a cast bar having a diameter of 0.5 mm and a length of 50 mm.

**[0018]** Table 1 shows the respective alloy compositions of Inventive Examples 1 to 14 and Comparative Examples 1 to 7, and the respective Curie temperatures ( $T_c$ ), glass transition temperatures ( $T_g$ ) and crystallization temperatures ( $T_{\chi}$ ) of Inventive Examples 1 to 14 measured using a differential scanning calorimeter. Further, the generated heat value due to crystallization in a sample was measured using a differential scanning calorimeter, and compared with that of a completely vitrified strip prepared through a single-roll rapid liquid cooling process to evaluate the volume fraction of a glass phase ( $V_f$ -amo.) contained in the sample.

**EP 1 482 064 A1**

**[0019]** Table 1 also shows the respective saturation magnetizations ( $I_s$ ) and coercive forces ( $H_c$ ) of Inventive Examples 1 to 14 measured using a vibrating-sample magnetometer and an I-H loop tracer.

5

10

15

20

25

30

35

40

45

50

55

Table 1

	Alloy Composition	Diameter (mm)	T <sub>g</sub> (K)	T <sub>x</sub> (K)	T <sub>x</sub> - T <sub>g</sub> (K)	T <sub>g</sub> /T <sub>m</sub>	V <sub>f-amo</sub>	Is (T)	Hc (A/m)
Inventive Example 1	(Fe <sub>0.75</sub> B <sub>0.15</sub> Si <sub>0.10</sub> ) <sub>99</sub> Nb <sub>1</sub>	0.5	815	858	43	0.56	100	1.50	3.7
Inventive Example 2	(Fe <sub>0.75</sub> B <sub>0.15</sub> Si <sub>0.10</sub> ) <sub>98</sub> Nb <sub>2</sub>	1.0	812	870	58	0.57	100	1.49	3.5
Inventive Example 3	(Fe <sub>0.75</sub> B <sub>0.15</sub> Si <sub>0.10</sub> ) <sub>96</sub> Nb <sub>4</sub>	1.5	835	885	50	0.61	100	1.48	3.0
Inventive Example 4	(Fe <sub>0.75</sub> B <sub>0.15</sub> Si <sub>0.10</sub> ) <sub>94</sub> Nb <sub>6</sub>	1.0	820	865	45	0.58	100	1.46	3.0
Inventive Example 5	(Fe <sub>0.75</sub> B <sub>0.15</sub> Si <sub>0.10</sub> ) <sub>92</sub> Nb <sub>8</sub>	0.5	815	855	40	0.57	100	1.43	3.5
Inventive Example 6	(Fe <sub>0.775</sub> B <sub>0.125</sub> Si <sub>0.10</sub> ) <sub>98</sub> Nb <sub>2</sub>	0.5	760	805	45	0.56	100	1.51	3.0
Inventive Example 7	(Fe <sub>0.775</sub> B <sub>0.125</sub> Si <sub>0.10</sub> ) <sub>96</sub> Nb <sub>4</sub>	1.0	755	810	55	0.59	100	1.49	2.5
Inventive Example 8	(Fe <sub>0.75</sub> B <sub>0.15</sub> Si <sub>0.10</sub> ) <sub>99</sub> Zr <sub>1</sub>	0.5	815	870	55	0.58	100	1.53	2.8
Inventive Example 9	(Fe <sub>0.75</sub> B <sub>0.15</sub> Si <sub>0.10</sub> ) <sub>98</sub> Zr <sub>2</sub>	0.5	810	860	50	0.58	100	1.51	3.0
Inventive Example 10	(Fe <sub>0.75</sub> B <sub>0.15</sub> Si <sub>0.10</sub> ) <sub>96</sub> Hf <sub>4</sub>	0.5	820	865	45	0.59	100	1.47	3.0
Inventive Example 11	(Fe <sub>0.75</sub> B <sub>0.15</sub> Si <sub>0.10</sub> ) <sub>94</sub> Hf <sub>6</sub>	1.0	815	865	50	0.60	100	1.45	3.0
Inventive Example 12	(Fe <sub>0.75</sub> B <sub>0.15</sub> Si <sub>0.10</sub> ) <sub>96</sub> Ta <sub>4</sub>	0.5	845	890	45	0.59	100	1.46	3.0
Inventive Example 13	(Fe <sub>0.75</sub> B <sub>0.15</sub> Si <sub>0.10</sub> ) <sub>94</sub> Ta <sub>6</sub>	1.0	830	880	50	0.60	100	1.45	2.7
Inventive Example 14	(Fe <sub>0.74</sub> Ga <sub>0.33</sub> B <sub>0.14</sub> Si <sub>0.09</sub> ) <sub>98</sub> Nb <sub>2</sub>	0.5	780	820	40	0.59	100	1.48	3.0
Comparative Example 1	Fe <sub>75</sub> B <sub>15</sub> Si <sub>10</sub>	0.5				crystalline			
Comparative Example 2	(Fe <sub>0.75</sub> B <sub>0.15</sub> Si <sub>0.10</sub> ) <sub>99.5</sub> Nb <sub>0.5</sub>	0.5				crystalline			
Comparative Example 3	(Fe <sub>0.775</sub> B <sub>0.125</sub> Si <sub>0.10</sub> ) <sub>99.5</sub> Nb <sub>0.5</sub>	0.5				crystalline			
Comparative Example 4	(Co <sub>0.705</sub> Fe <sub>0.045</sub> B <sub>0.15</sub> Si <sub>0.10</sub> ) <sub>99.5</sub> Nb <sub>0.5</sub>	0.5				crystalline			
Comparative Example 5	(Fe <sub>0.75</sub> B <sub>0.15</sub> Si <sub>0.10</sub> ) <sub>89</sub> Nb <sub>11</sub>	0.5				crystalline			
Comparative Example 6	(Fe <sub>0.8</sub> B <sub>0.2</sub> ) <sub>96</sub> Nb <sub>4</sub>	0.5				crystalline			
Comparative Example 7	(Fe <sub>0.8</sub> Si <sub>0.2</sub> ) <sub>96</sub> Nb <sub>4</sub>	0.5				crystalline			

[0020] Further, the vitrification in each of the cast bars of Inventive Examples 1 to 14 and Comparative Examples 1 to 7 was checked through X-ray diffraction analysis, and the sample sections were observed by an optical microscope.

[0021] In Inventive Examples 1 to 14, the supercooled-liquid temperature interval ( $\Delta T_{\chi}$ ) expressed by the following formula:  $\Delta T_{\chi} = T_{\chi} - T_g$  (wherein  $T_{\chi}$  is a crystallization temperature, and  $T_g$  is a glass transition temperature) was 40 K or more, and the volume fraction ( $V_{f-amo}$ ) of a glass phase was 100 % in the form of a cast bar with a diameter of 0.5 to 2.0 mm.

[0022] In contrast, Comparative Examples 1 which contains the element M in an amount of 1 atomic% or less or contains no element M were crystalline in the form of a cast bar with a diameter of 0.5 mm. While Comparative Example contains Nb as the element M, the content of Nb is 11 atomic% which is outside the alloy composition range of the present invention. As a result, it was crystalline in the form of a cast bar with a diameter of 0.5 mm. Comparative Examples 6 and 7 containing 4 atomic% of the element M but no Si or B were crystalline in the form of a cast bar with a diameter of 0.5 mm.

[0023] FIG. 1 is an optical micrograph showing the sectional structure of the obtained cast bar with a diameter of 1.5 mm. In the optical micrograph of FIG 1, no contrast of crystal particles is observed. This clearly proves the formation of metallic glass.

[0024] All of Inventive Examples has a high saturation magnetization of 1.4T or more. In particular, Inventive Examples 1 to 3 and 6 to 8 have a high saturation magnetization of 1.5T despite of high glass forming ability.

[Inventive Example 15]

[0025] A molten alloy with the same composition as that of Inventive Example 1 was rapidly solidified through a conventional melt-spinning process to prepare a ribbon material having a thickness of 0.025 mm and a width of 2 mm. FIG 2 shows thermal analysis curves of the cast bar obtained in Inventive Example 1 and the ribbon material obtained in Inventive Example 15. As seen in FIG 2, there is not any difference between the ribbon material and the bulk material.

[Inventive Example 16]

[0026] A molten alloy with the same composition as that of Inventive Example 3 was rapidly solidified through a conventional melt-spinning process to prepare a ribbon material having a thickness of 0.025 mm and a width of 2 mm. FIG 3 shows thermal analysis curves of the cast bar obtained in Inventive Example 3 and the ribbon material obtained in Inventive Example 16. As with the above case, no difference is observed between the ribbon material and the bulk material in FIG 3.

[0027] FIG 4 shows I-H hysteresis curves of the cast bar obtained in Inventive Example 1 and the ribbon obtained in Inventive Example 15, based on the measurement of their magnetic characteristics using a vibrating-sample magnetometer. These curves show that both the Inventive Example 1 and 15 exhibit excellent soft magnetic characteristics.

[0028] FIG 5 shows I-H hysteresis curves of the cast bar obtained in Inventive Example 3 and the ribbon obtained in Inventive Example 16, based on the measurement of their magnetic characteristics using a vibrating-sample magnetometer. These curves show that both the Inventive Example 3 and 16 exhibit excellent soft magnetic characteristics.

#### INDUSTRIAL APPLICABILITY

[0029] As mentioned above, the Fe-B-Si-base metallic glass alloy of the present invention has excellent glass forming ability which achieves a critical thickness or diameter of 1.5 mm or more and allows metallic glass to be obtained through a copper-mold casting process. Thus, the present invention can practically provide a large metallic glass product having high saturation magnetization.

#### Claims

1. A soft magnetic Fe-B-Si-based metallic glass alloy with high glass forming ability which has a supercooled-liquid temperature interval ( $\Delta T_{\chi}$ ) of 40 K or more, a reduced glass-transition temperature ( $T_g / T_m$ ) of 0.56 or more and a saturation magnetization of 1.4 T or more, said metallic glass alloy being represented by the following composition formula:

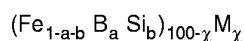

, wherein

## EP 1 482 064 A1

a and b represent an atomic ratio, and satisfy the following relations:  $0.1 \leq a \leq 0.17$ ,  $0.06 \leq b \leq 0.15$  and  $0.18 \leq a + b \leq 0.3$ ,

M is one or more elements selected from the group consisting of Zr, Nb, Ta, Hf, Mo, Ti, V, Cr, Pd and W, and  $\chi$  satisfies the following relation:  $1 \text{ atomic\%} \leq \chi \leq 10 \text{ atomic\%}$ .

5

2. The soft magnetic Fe-B-Si-based metallic glass alloy as defined in claim 1, which contains 3 atomic% or less of one or more elements selected from the group consisting of P, C, Ga and Ge.

10

15

20

25

30

35

40

45

50

55

**FIG. 1**

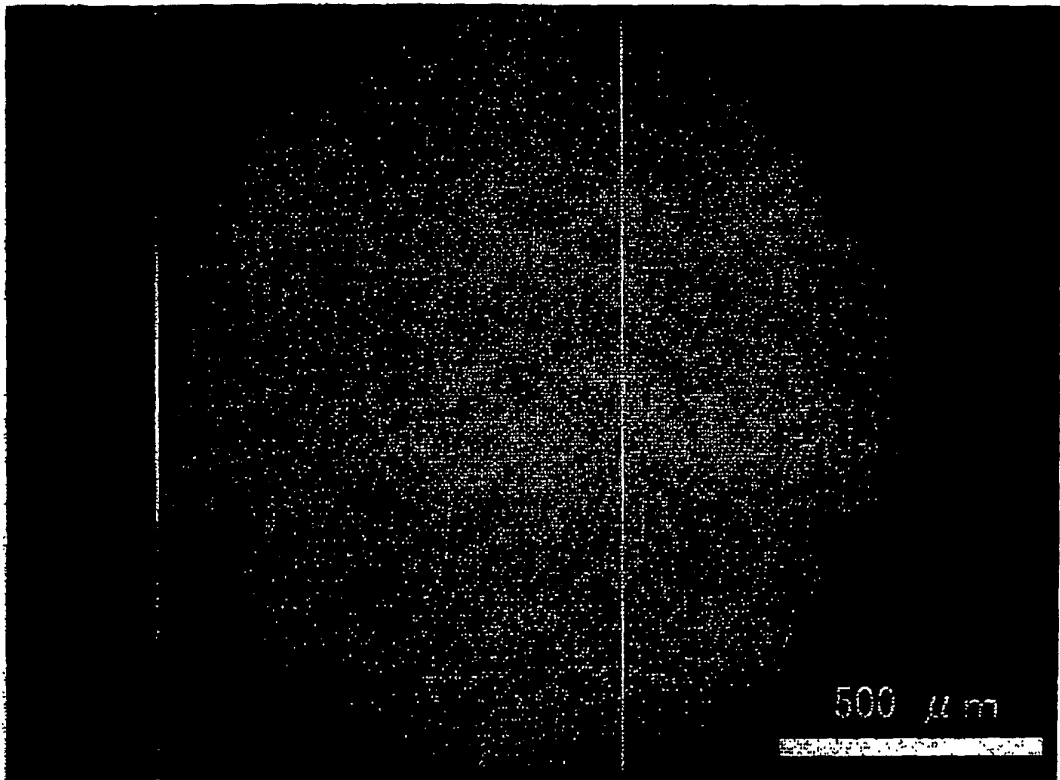



FIG. 2

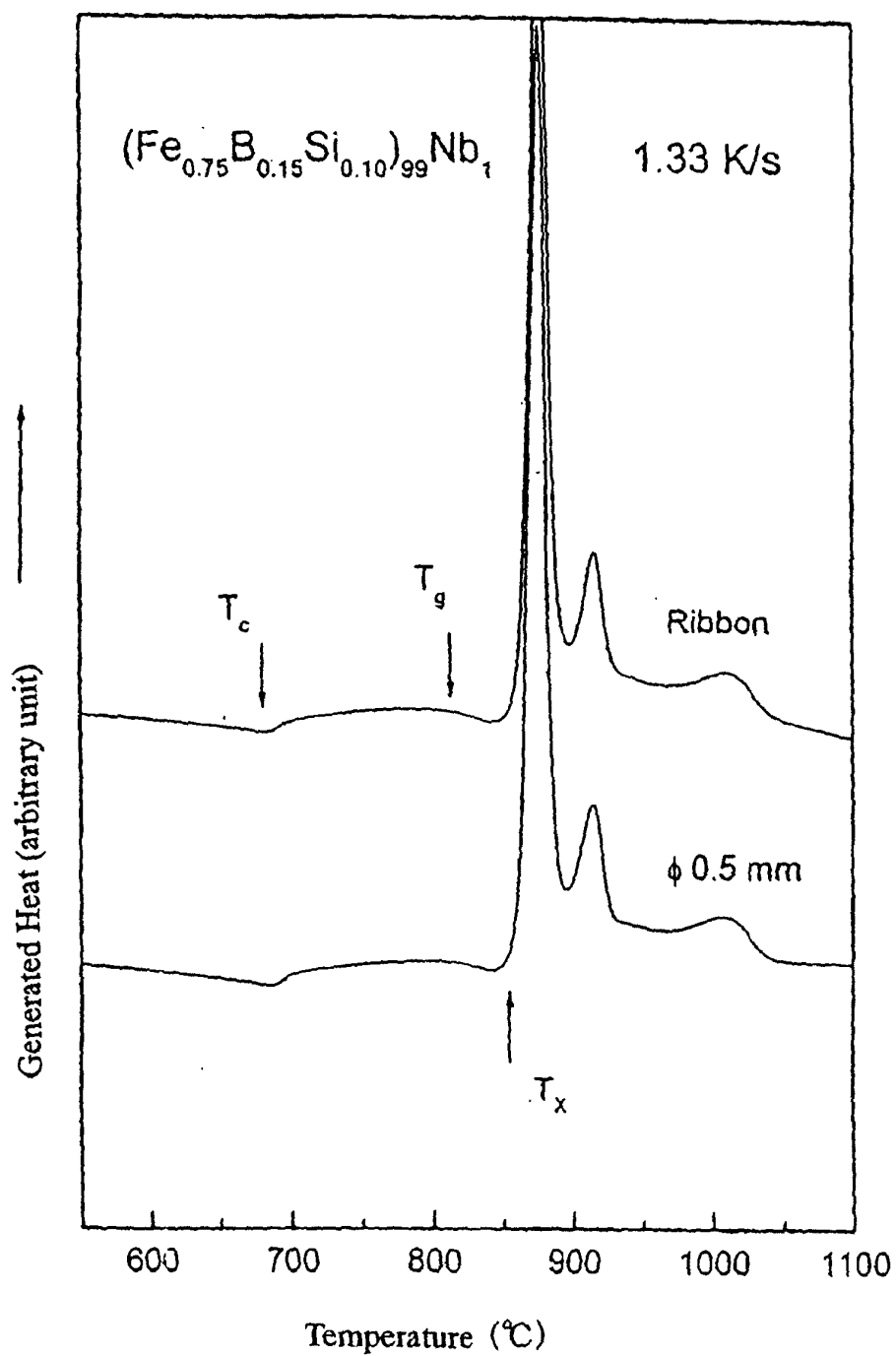

FIG. 3

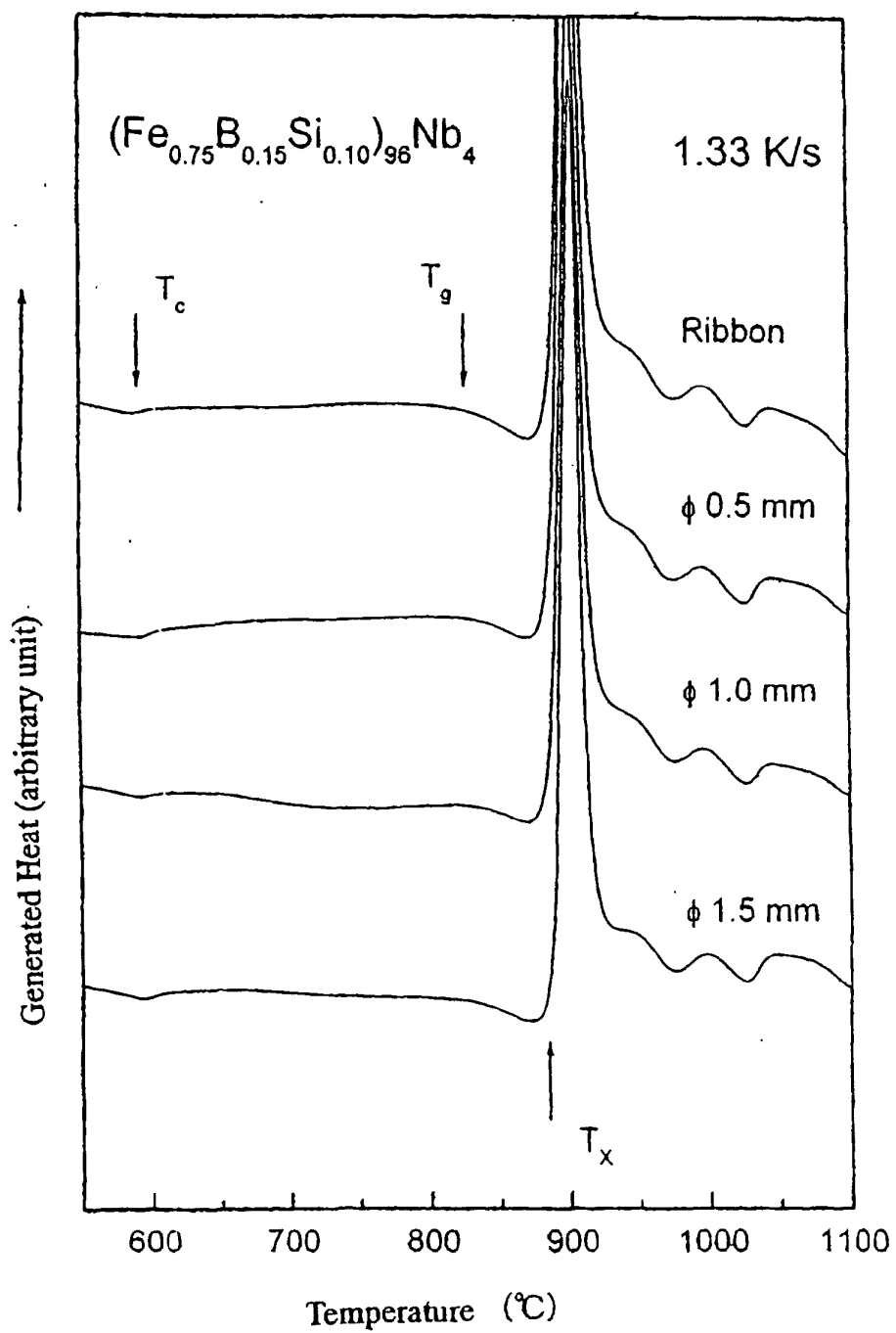

FIG. 4

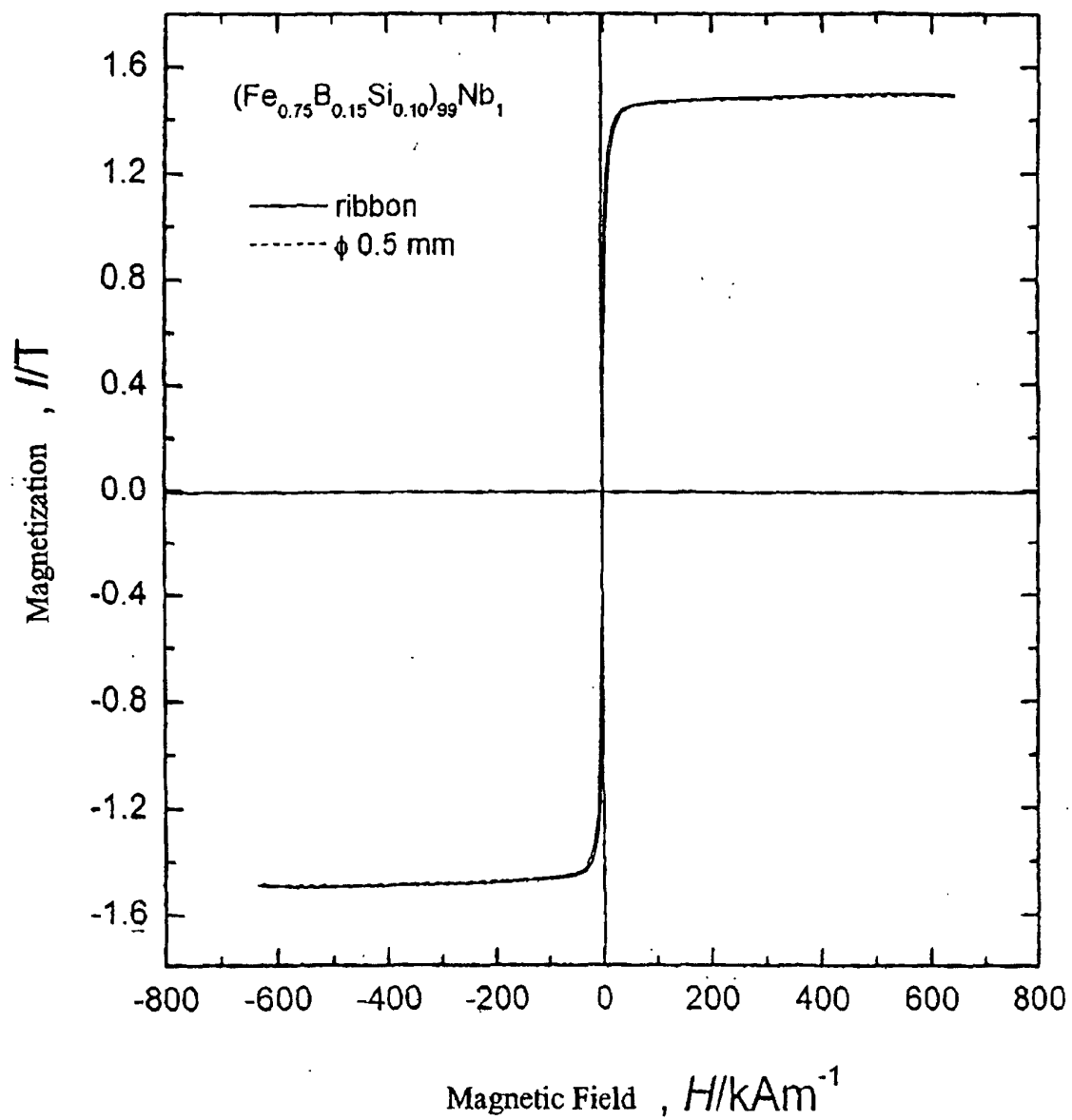

FIG 5

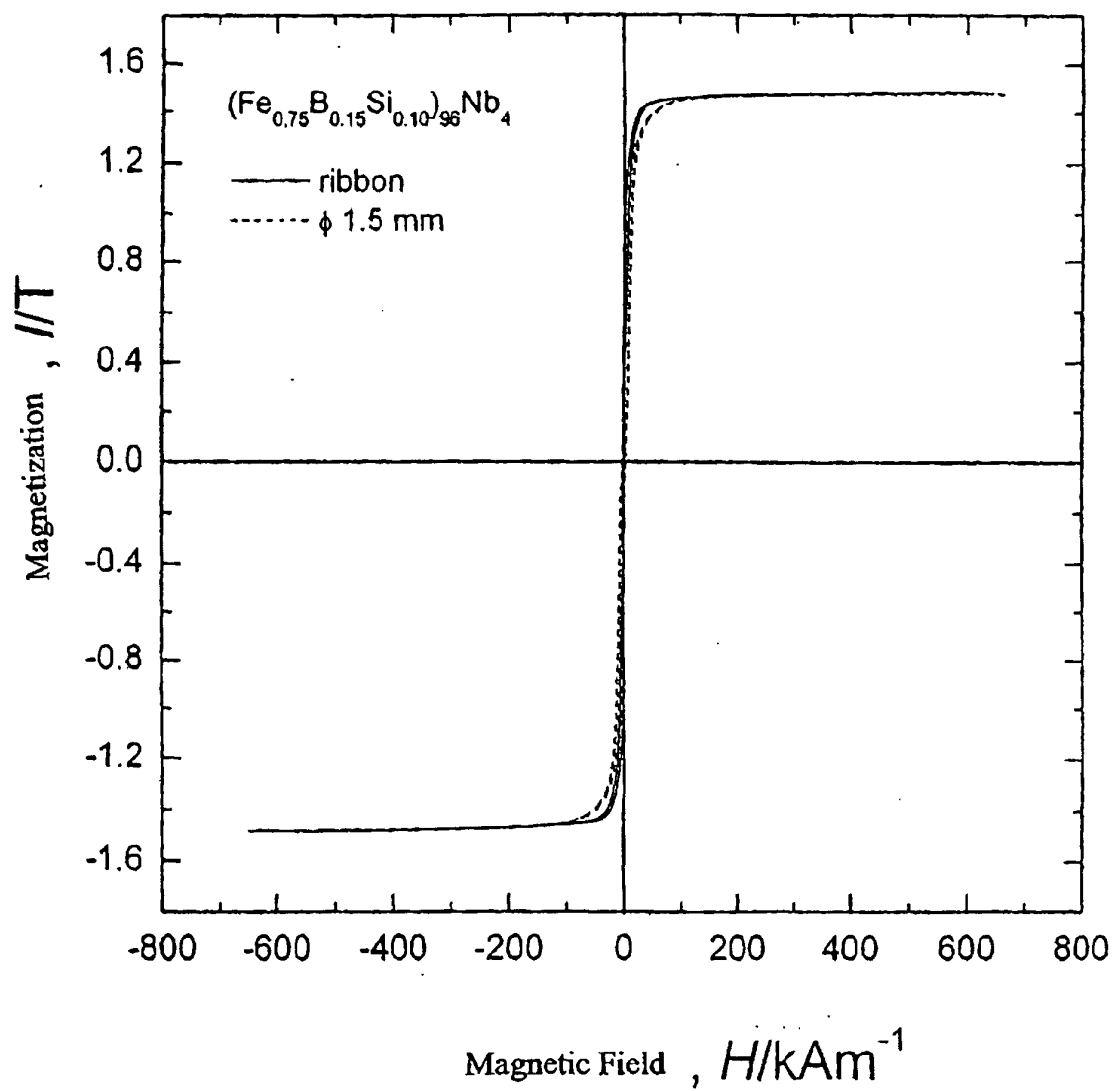
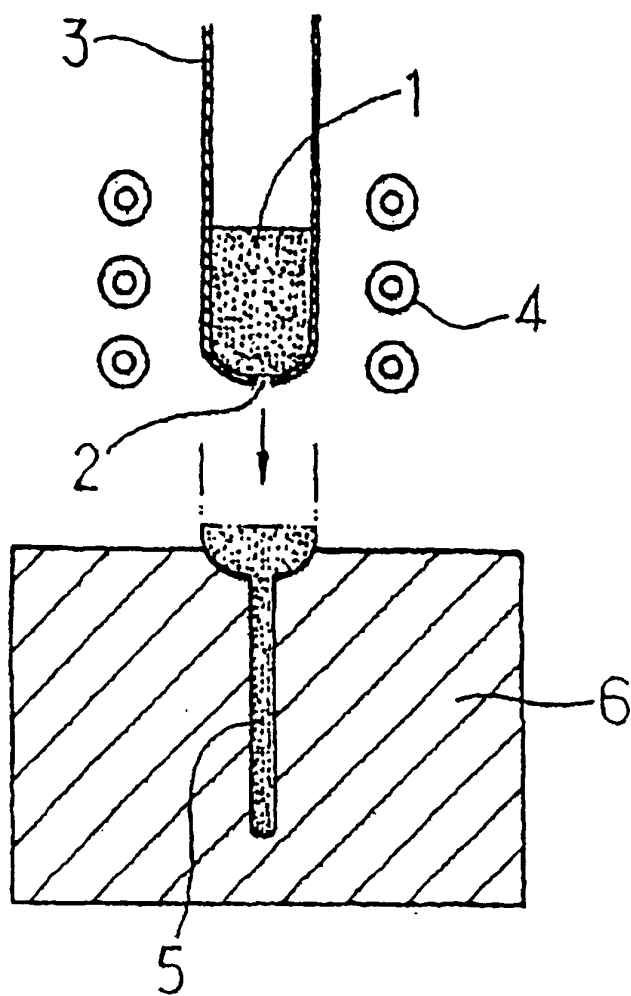

FIG. 6



## INTERNATIONAL SEARCH REPORT

International application No.

PCT/JP03/02257

A. CLASSIFICATION OF SUBJECT MATTER Int.Cl. <sup>7</sup> C22C45/02, H01F1/14		
According to International Patent Classification (IPC) or to both national classification and IPC		
B. FIELDS SEARCHED		
Minimum documentation searched (classification system followed by classification symbols) Int.Cl. <sup>7</sup> C22C38/00-45/10, H01F1/14		
Documentation searched other than minimum documentation to the extent that such documents are included in the fields searched Jitsuyo Shinan Koho 1926-1996 Toroku Jitsuyo Shinan Koho 1994-2003 Kokai Jitsuyo Shinan Koho 1971-2003 Jitsuyo Shinan Toroku Koho 1996-2003		
Electronic data base consulted during the international search (name of data base and, where practicable, search terms used)		
C. DOCUMENTS CONSIDERED TO BE RELEVANT		
Category*	Citation of document, with indication, where appropriate, of the relevant passages	Relevant to claim No.
X	JP 2001-279387 A (Nippon Steel Corp.), 10 October, 2001 (10.10.01), Claims; table 1 (Family: none)	1, 2
X	JP 61-295602 A (Hitachi Metals, Ltd.), 26 December, 1986 (26.12.86), Claims; table 1 (Family: none)	1, 2
X	US 5976274 A (Akihisa INOUE), 02 November, 1999 (02.11.99), Claims & AU 8433882 A1 & EP 72893 A1 & CA 1222646 A & KR 87/1283 B & JP 4-31846 A Claims	1, 2
<input checked="" type="checkbox"/> Further documents are listed in the continuation of Box C. <input type="checkbox"/> See patent family annex.		
* Special categories of cited documents: "A" document defining the general state of the art which is not considered to be of particular relevance "E" earlier document but published on or after the international filing date "L" document which may throw doubts on priority claim(s) or which is cited to establish the publication date of another citation or other special reason (as specified) "O" document referring to an oral disclosure, use, exhibition or other means "P" document published prior to the international filing date but later than the priority date claimed		"T" later document published after the international filing date or priority date and not in conflict with the application but cited to understand the principle or theory underlying the invention "X" document of particular relevance; the claimed invention cannot be considered novel or cannot be considered to involve an inventive step when the document is taken alone "Y" document of particular relevance; the claimed invention cannot be considered to involve an inventive step when the document is combined with one or more other such documents, such combination being obvious to a person skilled in the art "&" document member of the same patent family
Date of the actual completion of the international search 29 May, 2003 (29.05.03)		Date of mailing of the international search report 10 June, 2003 (10.06.03)
Name and mailing address of the ISA/ Japanese Patent Office		Authorized officer
Facsimile No.		Telephone No.

Form PCT/ISA/210 (second sheet) (July 1998)

## INTERNATIONAL SEARCH REPORT

International application No.

PCT/JP03/02257

C (Continuation). DOCUMENTS CONSIDERED TO BE RELEVANT		
Category*	Citation of document, with indication, where appropriate, of the relevant passages	Relevant to claim No.
X	US 4834816 A (ALLIED-SIGNAL INC.), 30 May, 1989 (30.05.89), Claims & DE 19802349 A1                      & JP 11-131199 A Claims	1,2

Form PCT/ISA/210 (continuation of second sheet) (July 1998)